

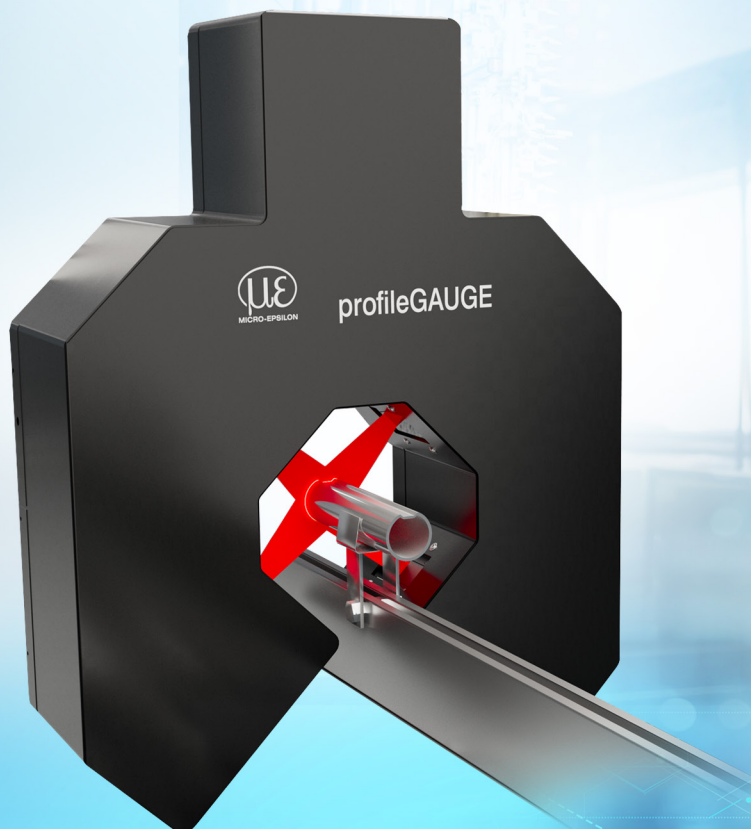

# More Precision

## **profileGAUGE X.LP-3D**

Sensor system for precise inline 3D profile measurement



# Measuring system for inline profile measurement

## profileGAUGE X.LP-3D

360° 3D profile and geometry measurement with four laser scanners

System accuracy up to  $\pm 5 \mu\text{m}$

Measurement of numerous surfaces and materials

Integrated software for evaluating various product geometries

Fully automatic calibration

Compact complete solution with 24 V supply

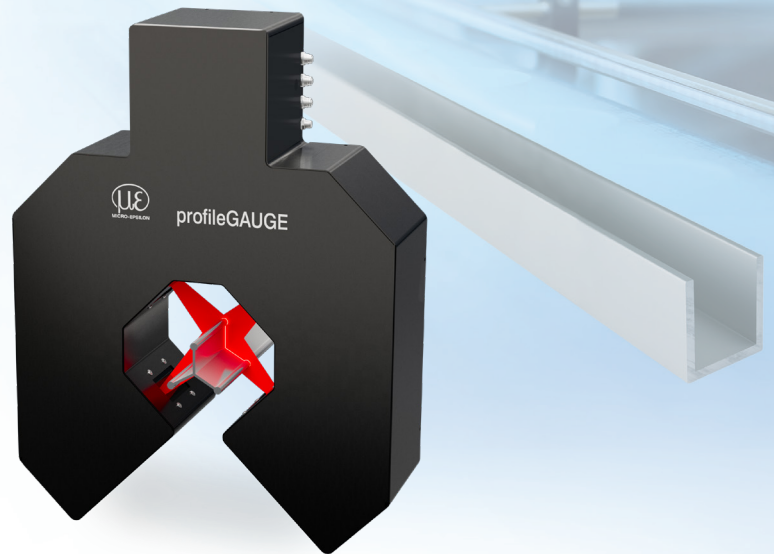

### 360° 3D profile inspection on the production line

The profileGAUGE X.LP-3D is a compact measuring system for 360° inspection of profiles and semi-finished products. Four laser scanners capture the measuring object from several viewing directions and enable reliable geometric evaluation directly in the production process. Each scanner projects a laser line onto the measuring object and calculates a precise height profile from the reflected line deformation (laser line triangulation). The software merges the four individual profiles into a 3D data set and automatically evaluates defined inspection characteristics.

The system is suitable for round material, square profiles, flat material, hexagonal profiles and free-form geometries, for example. Depending on the measurement task, width, thickness, angles, radii, depths, gap dimensions, diameters as well as form deviations, positional deviations and target/actual deviations are reliably inspected. Geometric defects are thus detected directly in the production process.

Parameterization is performed using the 3DInspect software. Measuring programs, test characteristics, tolerances and result variables are set up specifically for the application and processed automatically.

The relevant measured values and quality information are output according to the process requirements and can be transferred directly to the machine control system for monitoring and control. The profileGAUGE thus enables efficient inline quality assurance, early defect detection and stable process control in the production of profiles and semi-finished products.

### Automatic calibration in under 2 seconds

The profileGAUGE X.LP-3D has an automatic calibration function that supports reproducible measurement conditions during operation. This minimizes the effects of temperature changes, mechanical shifts or sensor drift. The evaluation software also supports the optimization of the calibration intervals for the respective ambient conditions.

The proven system design with measuring bracket, control cabinet, panel IPC and software minimizes the integration effort. The customizable sensor alignment allows the system to be specifically adapted to the respective measurement task. Other measuring ranges can be implemented on request.

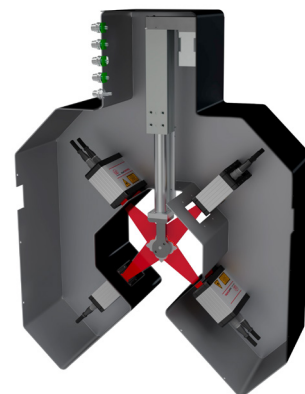

Model		X.LP-3D-50
Article number		4350882
Measuring range-System <sup>[1]</sup>	Standard	40 mm
	Extended	up to 120 mm <sup>[2]</sup>
System accuracy <sup>[3]</sup>		±5 µm
Resolution		8192 points/profile
Measuring rate <sup>[4]</sup>		typ. 100 Hz
Calibration <sup>[5]</sup>		automatic
Weight	Measuring bracket	40 kg
	Control cabinet + IPC	14 kg
Supply voltage		24 V
Humidity		5% RH ... 95% RH (non-condensing)
Protection class (DIN EN 60529)	Measuring bracket	IP40
	Control cabinet	IP54
	IPC	front IP65   rear IP20
Temperature range	Storage	-20 ... +65 °C
	Operation	+5 ... +45 °C
Material temperature		max. 45 °C
Range of workpieces		Round, square, flat, free-form, and hexagonal materials
Evaluation	3D evaluation software	Micro-Epsilon 3DInspect features
	Geometric parameters	Angle, width, thickness, radius, depth, gap, diameter, deviation from the target value
Control and indicator elements		Panel IPC with software included in the scope of supply

<sup>[1]</sup> Further measuring ranges available on request

<sup>[2]</sup> Possible on request, depending on the measuring object

<sup>[3]</sup> Depending on color and surface of the measuring object | 2 sigma; data valid for diffusely reflecting, metallic measuring standard (DAkkS certified)

<sup>[4]</sup> Max. 1 kHz, depending on the material, color, and measurement task

<sup>[5]</sup> Possible if the process is interrupted

## Powerful analysis and control software

The systems include a multi-touch industrial PC with a comprehensive software package. This allows production data to be displayed, monitored, analyzed and archived. The software provides various views and measurement modes.



## Accessory options

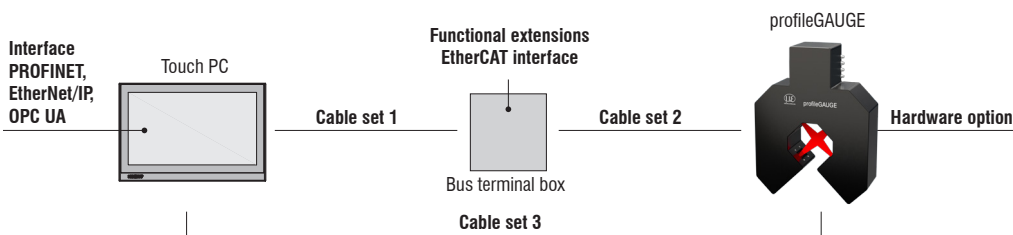

	Description	Article number
Cable set 1	free length 5 m	4350318
	free length 10 m	4350318.01
	free length 20 m	4350318.02
Cable set 2	free length 5 m	4350889.007
	free length 10 m	4350889.008
	free length 20 m	4350889.009
Cable set 3	free length 5 m	4350889.013
	free length 10 m	4350889.014
	free length 20 m	4350889.015
	free length 40 m	4350889.016
Functional extensions	Digital I/O extension (8x inputs, 8x outputs)	4350934
	RS422 encoder input extension (5 V)	4350935
	HTL encoder input extension (24 V)	4350936

	Description	Article number
Interfaces	Interface PROFINET	4350917
	Interface EtherNet/IP	4350924
	EtherCAT interface (additional Bus Terminal required)	4350937
	Interface OPC UA	4350938
Options	Set of sensor protective windows	4350889.001
	Customized sensor positions	4350889.003
	Customer-specific creation of one recipe based on measurement data from the line	4350889.004
	Customer-specific creation of up to 10 recipes based on measurement data from the line	4350889.005
	Customized calibration target	4350889.006

# Dimensions

## profileGAUGE X.LP-3D

Industrial PC with touchscreen

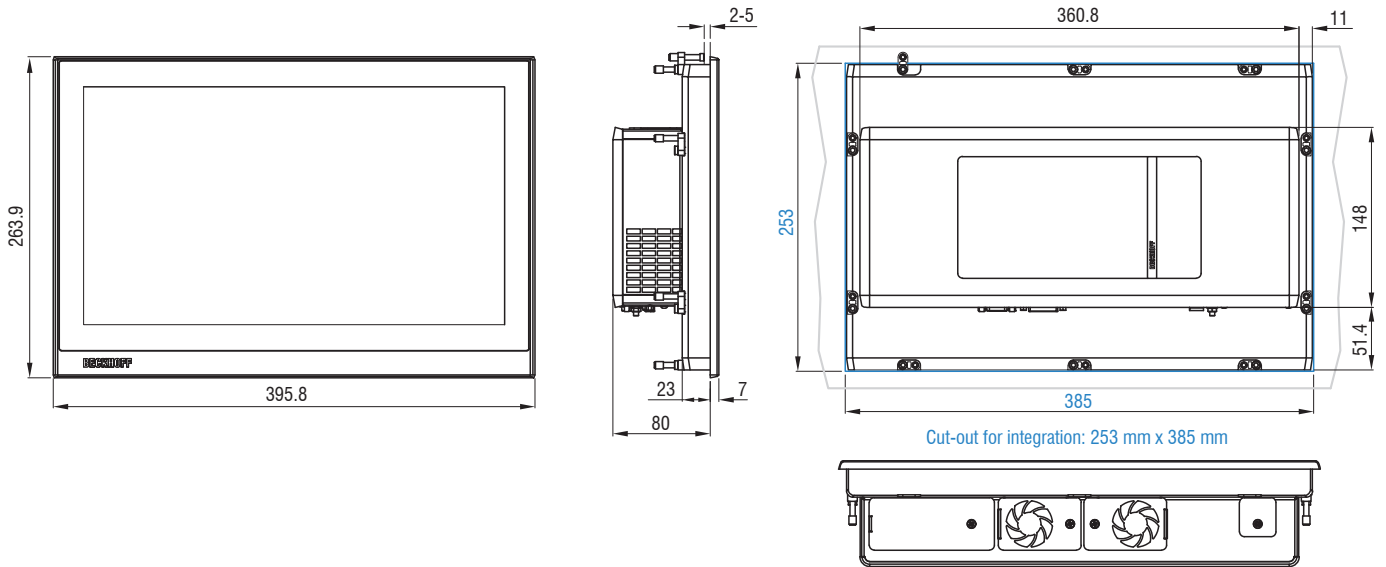
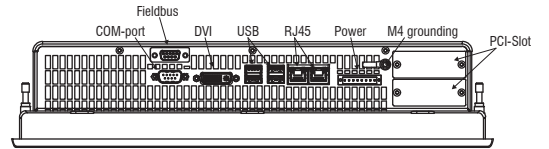

profileGAUGE

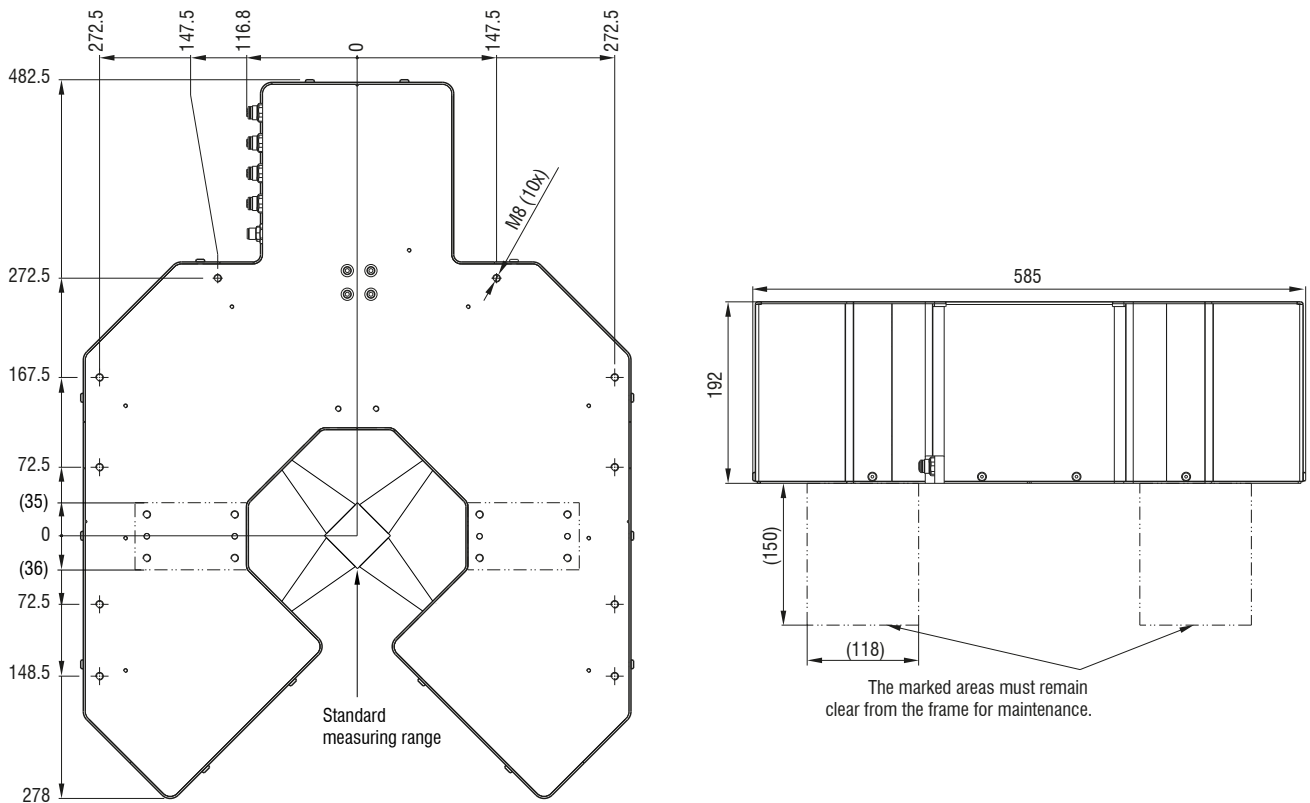

Dimensions in mm, not to scale.