



More Precision

thermoMETER // Non-contact infrared temperature sensors





thermoMETER CTratioM1

Glass fiber ratio pyrometer provides extremely short response time with hot objects

- Measuring range from 700°C to 1800°C
- Extremely short response times from 5ms
- Resistant to disturbances such as smoke, fog and partially concealed or moving objects
- Measurement depends only on the emissivity ratio but not on the absolute emissivity
- The measurement object can be smaller than the measurement spot
- Up to 250°C ambient temperature without cooling
- High optical resolution with selectable focal point
- Integrated sighting laser marks spot size
- Programmable 1- or/and 2-channel mode
- Separate controller with programming keys and backlit display

Optical specifications thermoMETER CTratioM1

Standard Focus										
SF40 lens	40:1	6.6	10.6	21.1	31.3	41.4	52	62.6	73.3	84
distance in mm		102	305	762	1143	1524	1905	2286	2667	3048
Close Focus										
CF02 lens	2:1	5.1	6.4	7.7	23.6	50.1	77.6	104.1		
distance in mm		102	200	305	762	1524	2286	3048		

Model	CTRM-1CF02-C3	CTRM-1SF40-C3
Optical resolution (95% energy)	40:1	
Temperature range	700°C to 1800°C	
Spectral range	0.7 to 1.1µm	
System accuracy ^{1,3}	±(1% of reading + 1°C)	
Repeatability ^{1,3}	±(0.5% of reading + 1°C)	
Temperature resolution (>900°C)	0.1°C	
Response time (95% signal) ²	5ms - 10s	
Emissivity ratio ⁴	0.800 to 1.200	
Emissivity ⁴	0.100 to 1.100	
Signal processing ⁴	1 color / 2 color mode; attenuation monitoring / alarms; peak hold, valley hold, average; extended hold function with threshold and hysteresis	
Outputs/analog	0/4 - 20mA, 0 to 5/10V	
Outputs/analog optional	relays: 2 x 60VDC/42 VAC _{eff} ; 0.4A; electrically isolated	
Alarm output	2 x open collector (24V / 1A)	
Outputs/digital optional	USB (only for sensor configuration)	
Output impedances	current output	mA max. 500Ω (with 5 to 36VDC)
	voltage output	min. 100kΩ load impedance
Inputs/outputs digital	2 programmable in-/ outputs, usable as: alarm output (open collector output [24V / 1A]), digital input for triggered signal output and peak hold function	
Fiber cable length	3m (standard), 6m, 10m, 15m, 22m; stainless steel armor, 400µm fiber diameter	
Power supply	8 to 36VDC or USB; max. 200mA	
Optical aiming	Laser 650nm, 1mW, ON/OFF via controller or software	
Protection class	IP65 (NEMA-4)	
Ambient temperature	sensor: -20°C to 250°C (70°C if Laser ON); controller: 0°C to 85°C	
Storage temperature	sensor: -40°C to 250°C; controller: -40°C to 85°C	
Relative humidity	10 to 95%, non-condensing	
Vibration sensor	IEC 68-2-6: 3 G, 11-200Hz, any axis	
Shock sensor	IEC 68-2-27: 50 G, 11ms, any axis	
Weight	fiber cable with sensor: 375g; controller: 420g	

¹ ε= 1, response time 1s

² with dynamic adaption at low signal levels

³ ± ambient temperature 23±5°C

⁴ adjustable via programming keys or software

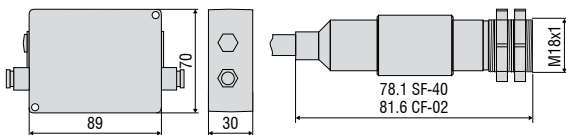

Product identification

CTRM -	1	CF02-	C3
Fiber cable length [3m (standard) / 6 / 10 / 15 / 22m]			
Focus [CF2 / SF40]			
Spectral range [0.7 to 1.1µm]			
thermoMETER CTRatio			



LASER LIGHT
DO NOT STARE INTO BEAM
CLASS 2 LASER
DIN EN 60825-1:2007
1mW / 630-650nm

CTLaser / CTLaserFAST / CTLaserGLASS / CTLaserM1/M2/M3/M5 / CTLaserCOMBUSTION

Controller

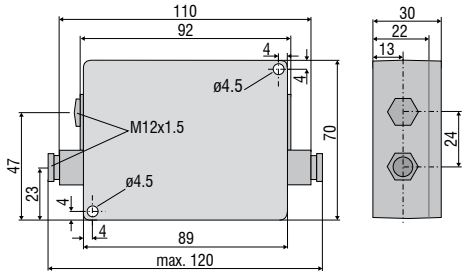

Sensor

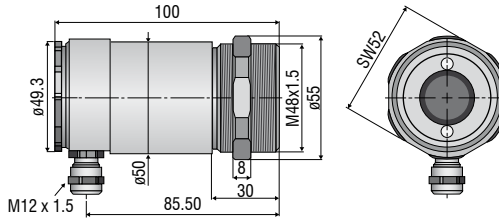

CTratioM1

Controller

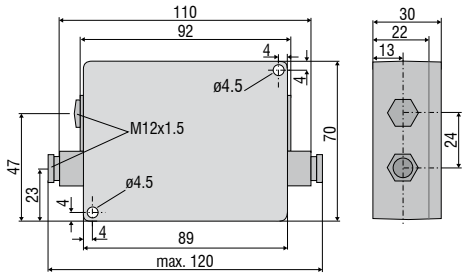

Sensor

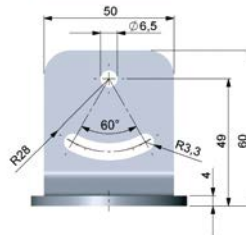
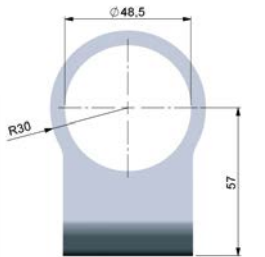
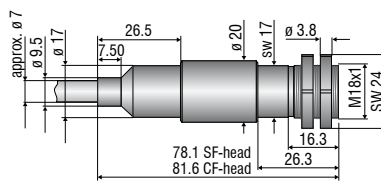

TM-FB-CTL Mounting bracket (fixed); included in CTL scope of supply

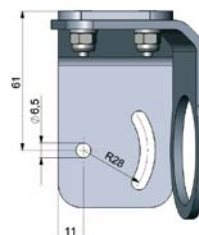
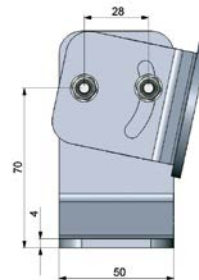

TM-AB-CTL Mounting bracket (adjustable)



TM-W-CTL Water cooled housing and air purge collar TM-AP-CTL, mounted on adjustable mounting bracket TM-AB-CTL

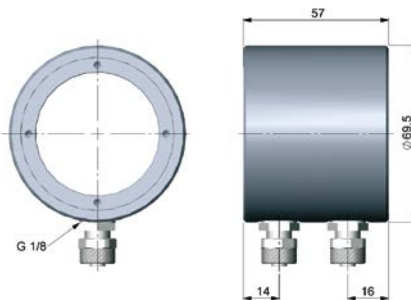

TM-W-CTL Water cooled housing

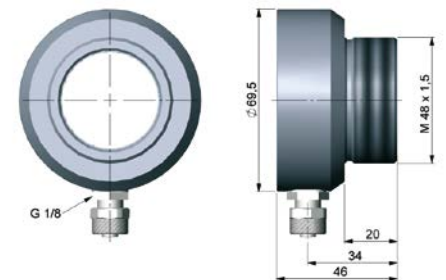

TM-AP-CTL Air purge collar



Mechanical accessories		
Art. No.	Model	
2970238	TM-AB-CTL	Mounting bracket, adjustable, stainless steel
2970239	TM-AP-CTL	Air purge collar, stainless steel
2970240	TM-W-CTL	Water cooled housing, stainless steel, for ambient temperatures up to 175°C
2970241	TM-RAIL-CTL	Rail mount adapter for CTLaser controller
2970242	TM-COV-CTL	Closed cover for controller
2970243	TM-MN-CTL	Mounting nut, stainless steel (spare)
2970244	TM-FB-CTL	Mounting bracket, fixed, stainless steel (spare)
2970298	TM-A20UN-CTL	Screw adapter M48x1.5 on 20UN-2A screw including mounting nut

High temperature accessories		
2970366	TM-J-CTL	Cooling jacket (length 228mm, ø89mm) (conversion kit TM-CONK-CTL is required)
2970374	TM-CONK-CTL	Conversion kit for CTL on axial cable exit, for integration in cooling jacket
2970368	TM-JAB-CTL	Adjustable mounting bracket for cooling jacket
2970369	TM-MF-CTL	Mounting flange M48x1.5 for TM-PF-CTL
2970370	TM-AST300-CTL	Reflection protection tube M48x1.5, 300mm length
2970371	TM-PA-CTL	Pipe adapter M48x1.5
2970372	TM-RM-CTL	Furnace wall mount accessory for CTL (TM-MF-CTL, TM-AST300-CTL and TM-PA-CTL)
2970412	TM-PF-CTL	Pipe flange M48x1.5 for directly mounting a CTL sensor
2970487	TM-CJA-CTL	Cooling Jacket Advanced - universal cooling jacket for CSLaser, CTLaser and CTVideo / CSVideo up to 315°C

Calibration		
2970253	TM-CERT-CTL	Certificate of calibration
2970324	TM-HTCERT-CTL	Certificate of calibration for CTLaser M1-/M2-/M3-/M5-/G-sensors

Interfaces		
2970245	TM-USBK-CTL	USB interface, computer cable, CompactConnect software second cable gland for controller
2970246	TM-RS232K-CTL	RS232 interface, computer cable, CompactConnect software, second cable gland for controller
2970338	TM-RS485USBK-CTL	RS485-USB-adapter, incl. PC cable, CompactConnect software and CTmulti, second cable gland for use with interface board TM-RS485B-CTL
2970248	TM-RS485B-CTL	RS485 interface board incl. second cable gland
2970249	TM-CANK-CTL	CAN-Bus interface; protocol: CANopen Presets: module address20 (14H), 250kbaud, 0-60°C
2970250	TM-PFBDPK-CTL	Profibus-DPV1 interface with plug-in connection
2970251	TM-ETHNK-CTL	Ethernet-Kit: interface board, external Ethernet adapter, CompactConnect software, second cable gland
2970252	TM-RI-CTL	Relay interface: two electrically isolated relays, 60VDC/ 42VAC _{eff} 0.4A

Sensor cables and high temperature cables for CTLaser		
2970374	TM-CONK-CTL	Connector-Kit for cables with connector
4800254.003	TM-CB3C-CTL	Sensor cable with connector (3m)
4800254.003H	TM-CB3HC-CTL	High-temperature sensor cable (up to 180°C) with connector (3m)
4800254.008	TM-CB8C-CTL	Sensor cable with connector (8m)
4800254.008H	TM-CB8HC-CTL	High-temperature sensor cable (up to 180°C) with connector (8m)
4800254.015	TM-CB15C-CTL	Sensor cable with connector (15m)
4800254.015H	TM-CB15HC-CTL	High-temperature sensor cable (up to 180°C) with connector (15m)



TM-J-CTL Cooling jacket (length 228mm, ø 89mm) with adjustable mounting bracket TM-JAB-CTL; suitable for ambient temperatures up to 180°C

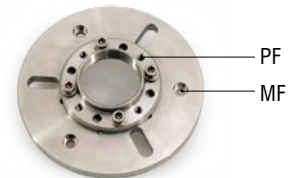

TM-PF-CTL and TM-MF-CTL mounting flange M48x1.5 for directly mounting a CTL sensor

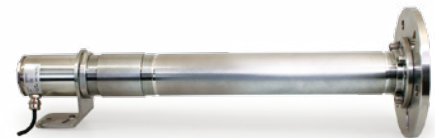

TM-RM-CTL Furnace wall mount accessory for CTLaser / CTratio: TM-MF-CTL, TM-PF-CTL, TM-AST300-CTL and TM-PA-CTL

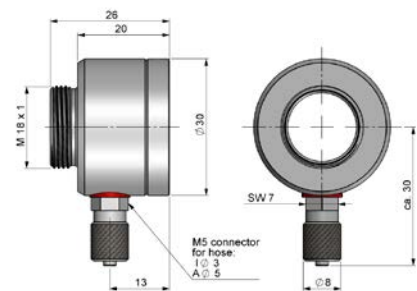

TM-AP-CTR Air purge collar

CTratio		
Art. No.	Model	
2970348	TM-FB-CTR	Mounting bracket, stainless steel, adjustable in one axis
2970395	TM-AP-CTR	Air purge collar, stainless steel
2970373	TM-RM-CTR	Furnace wall mount
2970351	TM-CERT-CTR	Certificate of calibration

Further IR temperature measurement devices from Micro-Epsilon



thermoIMAGER TIM
Compact USB thermal imaging cameras
for precise thermography



thermoMETER CTVideo/CSVideo
Infrared temperature sensors with crosshair
laser sighting and video output



thermoMETER Handheld
Innovative handheld pyrometer with laser
sighting for inspection and maintenance