



More Precision

thermoMETER // Non-contact infrared temperature sensors





thermoMETER CTLaserM5

Non-contact IR temperature sensor with laser sighting for exact temperature measurement of molten metals

- Measuring range from 1000°C to 2000°C
- Short measuring wavelength of 525nm minimizes errors due to emissivity uncertainty and misadjustment
- Response time of 1ms
- Double laser marks the exact spot size from 1mm
- For metal processing and measurements of metal oxides and ceramics
- Optical resolution 150:1 with selectable focus
- Up to 85°C ambient temperature without cooling, automatic laser switch-off at 50°C
- Selectable and scalable analog output, optional digital interfaces

Optical specifications thermoMETER CTLaserM5

□ = smallest spot size / focal point (mm)

Standard Focus

1L/2L SF	150:1	20	18.3	16.5	14.8	13.1	11.3	9.6	8.5	7.3	9.8	13.5	17.2	23.4	29.6
	distance in mm	0	150	300	450	600	750	900	1000	1100	1200	1350	1500	1750	2000

Far Focus

1L/2L FF	150:1	20	20.5	21	21.5	22	22.5	23	23.3	24	28.9	41.1	53.3	62.5	
	distance in mm	0	450	900	1350	1800	2250	2700	3000	3600	4000	5000	6000	6750	

Model	CTLM-5SF150-C3	
Optical resolution	150:1	
Temperature range ¹	1000 to 2000°C	
Spectral range	525nm	
System accuracy ²	±1% of reading (≤ 1100°C) ± 0.3% of reading +2°C (> 1100°C)	
Repeatability ²	±0.5% of reading (≤ 1100°C) ± 0.1% of reading +1°C (> 1100°C)	
Temperature resolution	0.2°C	
Response time (90% signal) ³	1ms	
Emissivity/gain ¹	0.100 to 1.100	
Transmissivity/gain ¹	0.100 to 1.000	
Signal processing ¹	peak hold, valley hold, average; extended hold function with threshold and hysteresis	
Certificate of calibration	optional	
Outputs/analog	channel 1	0/4 to 20mA, 0 to 5/10V, thermocouple J, K
Outputs/analog	optional	relays: 2 x 60VDC/42 VAC _{eff} ; 0.4A; electrically isolated
Alarm output		open collector (24V / 50A)
Outputs/digital	optional	USB, RS232, RS485, CAN, Profibus DP, Ethernet
Output impedances	current output	mA max. 500Ω (with 5 - 36VDC)
	voltage output	mV min. 100kΩ load impedance; thermocouple 20Ω
Inputs	programmable functional inputs for external emissivity adjustment ambient temperature compensation, trigger (reset of hold functions)	
Cable length	3m (standard), 8m, 15m	
Power supply	8 to 36VDC; max. 160mA	
Laser	class II (635nm), 1mW, ON/OFF via controller or software	
Protection class	IP65 (NEMA-4)	
Ambient temperature	sensor: -20°C to 85°C (50°C if Laser ON); controller: 0°C to 85°C	
Storage temperature	sensor: -40°C to 85°C controller: -40°C to 85°C	
Relative humidity	10 to 95%, non-condensing	
Vibration	sensor	IEC 68-2-6: 3 G, 11-200Hz, any axis
Shock	sensor	IEC 68-2-27: 50 G, 11ms, any axis
Weight	sensor: 600g; controller: 420g	

¹ adjustable via controller or software

² ε=1, response time 1s; ambient temperature: 23±5°C

³ with dynamic adaption at low signal levels

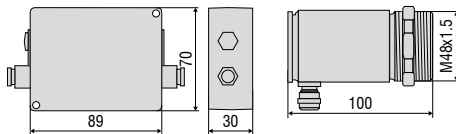

Product identification

CTLM -	5	SF150-	C3
Cable length [3m (standard) / 8m / 15m]			
Focus [SF / FF]			
Spectral range [525nm]			
thermoMETER CTLaserM			

Accessories page 20 - 21

- Mounting bracket
- Air purge collar
- Rail mount adapter for controller
- Water cooled housing
- Interface kit
- Certificate of calibration



LASER LIGHT
DO NOT STARE INTO BEAM
CLASS 2 LASER
DIN EN 60825-1:2007
1mW / 630-650nm

CTLaser / CTLaserFAST / CTLaserGLASS / CTLaserM1/M2/M3/M5 / CTLaserCOMBUSTION

Controller

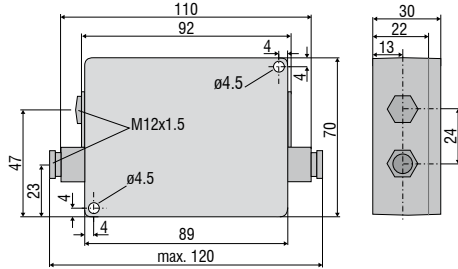

Sensor

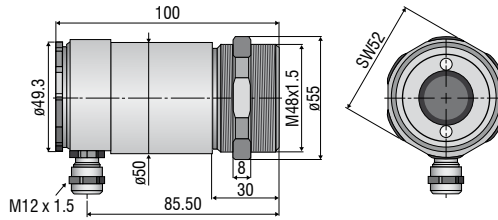

CTratioM1

Controller

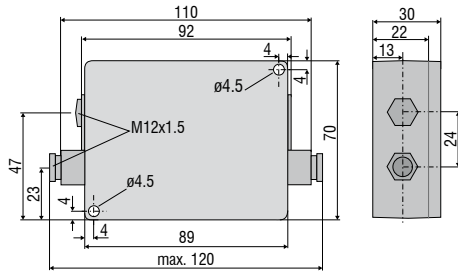

Sensor

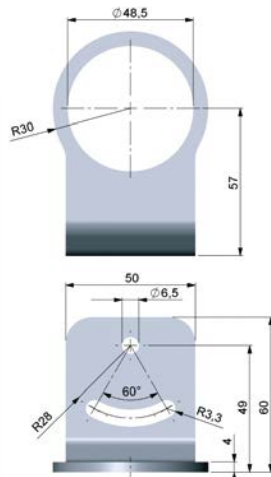
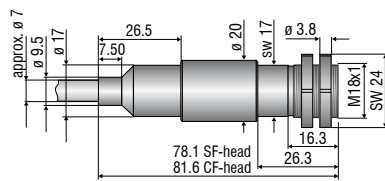

TM-FB-CTL Mounting bracket (fixed); included in CTL scope of supply

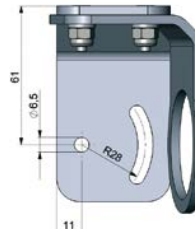
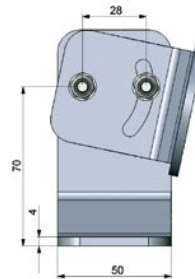

TM-AB-CTL Mounting bracket (adjustable)

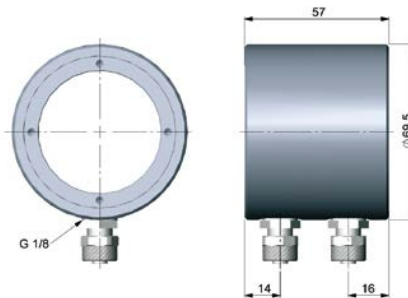

TM-W-CTL Water cooled housing

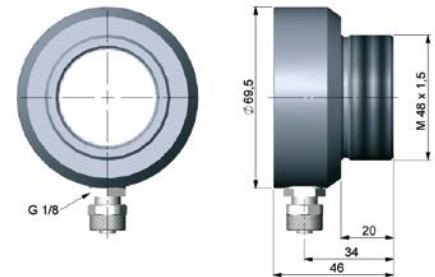

TM-AP-CTL Air purge collar

TM-W-CTL Water cooled housing and air purge collar TM-AP-CTL, mounted on adjustable mounting bracket TM-AB-CTL

Mechanical accessories		
Art. No.	Model	
2970238	TM-AB-CTL	Mounting bracket, adjustable, stainless steel
2970239	TM-AP-CTL	Air purge collar, stainless steel
2970240	TM-W-CTL	Water cooled housing, stainless steel, for ambient temperatures up to 175°C
2970241	TM-RAIL-CTL	Rail mount adapter for CTLaser controller
2970242	TM-COV-CTL	Closed cover for controller
2970243	TM-MN-CTL	Mounting nut, stainless steel (spare)
2970244	TM-FB-CTL	Mounting bracket, fixed, stainless steel (spare)
2970298	TM-A20UN-CTL	Screw adapter M48x1.5 on 20UN-2A screw including mounting nut

High temperature accessories		
Art. No.	Model	
2970366	TM-J-CTL	Cooling jacket (length 228mm, ø89mm) (conversion kit TM-CONK-CTL is required)
2970374	TM-CONK-CTL	Conversion kit for CTL on axial cable exit, for integration in cooling jacket
2970368	TM-JAB-CTL	Adjustable mounting bracket for cooling jacket
2970369	TM-MF-CTL	Mounting flange M48x1.5 for TM-PF-CTL
2970370	TM-AST300-CTL	Reflection protection tube M48x1.5, 300mm length
2970371	TM-PA-CTL	Pipe adapter M48x1.5
2970372	TM-RM-CTL	Furnace wall mount accessory for CTL (TM-MF-CTL, TM-AST300-CTL and TM-PA-CTL)
2970412	TM-PF-CTL	Pipe flange M48x1.5 for directly mounting a CTL sensor
2970487	TM-CJA-CTL	Cooling Jacket Advanced - universal cooling jacket for CSLaser, CTLaser and CTVideo / CSVideo up to 315°C

Calibration		
Art. No.	Model	
2970253	TM-CERT-CTL	Certificate of calibration
2970324	TM-HTCERT-CTL	Certificate of calibration for CTLaser M1-/M2-/M3-/M5-/G-sensors

Interfaces		
Art. No.	Model	
2970245	TM-USBK-CTL	USB interface, computer cable, CompactConnect software second cable gland for controller
2970246	TM-RS232K-CTL	RS232 interface, computer cable, CompactConnect software, second cable gland for controller
2970338	TM-RS485USBK-CTL	RS485-USB-adapter, incl. PC cable, CompactConnect software and CTmulti, second cable gland for use with interface board TM-RS485B-CTL
2970248	TM-RS485B-CTL	RS485 interface board incl. second cable gland
2970249	TM-CANK-CTL	CAN-Bus interface; protocol: CANopen Presets: module address20 (14H), 250kbaud, 0-60°C
2970250	TM-PFBDPK-CTL	Profibus-DPV1 interface with plug-in connection
2970251	TM-ETHNK-CTL	Ethernet-Kit: interface board, external Ethernet adapter, CompactConnect software, second cable gland
2970252	TM-RI-CTL	Relay interface: two electrically isolated relays, 60VDC/ 42VAC _{eff} 0.4A

Sensor cables and high temperature cables for CTLaser		
Art. No.	Model	
2970374	TM-CONK-CTL	Connector-Kit for cables with connector
4800254.003	TM-CB3C-CTL	Sensor cable with connector (3m)
4800254.003H	TM-CB3HC-CTL	High-temperature sensor cable (up to 180°C) with connector (3m)
4800254.008	TM-CB8C-CTL	Sensor cable with connector (8m)
4800254.008H	TM-CB8HC-CTL	High-temperature sensor cable (up to 180°C) with connector (8m)
4800254.015	TM-CB15C-CTL	Sensor cable with connector (15m)
4800254.015H	TM-CB15HC-CTL	High-temperature sensor cable (up to 180°C) with connector (15m)



TM-J-CTL Cooling jacket (length 228mm, ø 89mm) with adjustable mounting bracket TM-JAB-CTL; suitable for ambient temperatures up to 180°C

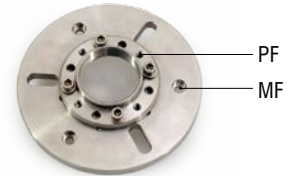

TM-PF-CTL and TM-MF-CTL mounting flange M48x1.5 for directly mounting a CTL sensor



TM-RM-CTL Furnace wall mount accessory for CTLaser / CTratio: TM-MF-CTL, TM-PF-CTL, TM-AST300-CTL and TM-PA-CTL

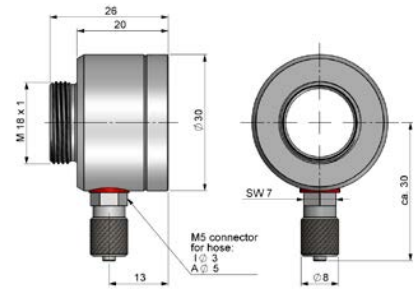

TM-AP-CTR Air purge collar

CTratio		
Art. No.	Model	
2970348	TM-FB-CTR	Mounting bracket, stainless steel, adjustable in one axis
2970395	TM-AP-CTR	Air purge collar, stainless steel
2970373	TM-RM-CTR	Furnace wall mount
2970351	TM-CERT-CTR	Certificate of calibration

Further IR temperature measurement devices from Micro-Epsilon



thermoIMAGER TIM
Compact USB thermal imaging cameras
for precise thermography



thermoMETER CTVideo/CSVideo
IR temperature sensors with crosshair laser
sighting and video output



thermoMETER Handheld
Innovative handheld pyrometer with laser
sighting for inspection and maintenance