



More Precision

thermoMETER // Non-contact IR temperature sensors





thermoMETER CSmicro 2W

Miniature OEM two-wire IR temperature sensor with controller integrated in the cable

- Measuring range from -40°C to 1600°C
- Applicable in ambient temperatures up to 180°C without cooling (sensor)
- Robust, silicon-coated lens
- Integrated controller with LED alarm display and intelligent sighting aid, alarm signal, temperature-code display or self-diagnostics
- Integrated controller in the cable
- Scalable analog output and simultaneous alarm output
- Protection against short circuit and polarity change
- Programmable controller
- Optional USB interface and software for programming
- Best price - ideal for OEM applications

Optical specifications thermoMETER CSmicro 2W

□ = smallest spot size (mm)

Standard Focus

SF15	15:1	7	8	13	20	27	33	40	47	53
SF22	22:1	7	7	9	14	18	23	27	32	36
	distance (mm)	0	100	200	300	400	500	600	700	800
SF40	40:1	7	7	10	15	20	25	30	35	40
SF75	75:1	7	7	7	8	11	14	17	20	23
	distance (mm)	0	200	400	600	800	1000	1200	1400	1600

Close Focus (with optionally available CF lens)

CF15	15:1	7	5	0.8	5	11	16	21	27	32
CF22	22:1	7	4	0.6	4	8	12	16	20	24
	distance (mm)	0	5	10	15	20	25	30	35	40

Close Focus (integrated CF lens in the sensor head)

CF40	40:1	6.5	4.5	2.7	6	10.3	14.5	18.6	22.8	27
CF75	75:1	6.5	3.8	1.5	4.4	8.1	11.7	15.4	19	22.6
	distance (mm)	0	60	110	150	200	250	300	350	400

Model	CSmi2W-SF15-C1	CSmi2W-SF15H-C1	CSmi2W-SF22H-C1	CSmi2WM-2SF40-C1	CSmi2WM-2SF75-C1
Optical resolution	15:1		22:1	40:1	75:1
Temperature range	-40°C to 1030°C ¹			250°C to 800°C ¹	385°C to 1600°C ¹
Spectral range	8 to 14µm			1.6µm	
System accuracy	±1.0% or ±1.5°C ³			±(0.3% of reading +2°C) ⁴	
Repeatability	±0.5% or ±0.75°C ³			±(0.1% of reading +1°C) ⁴	
Temperature coefficient	±0.05K/K or ±0.05% K ⁵				
Temperature resolution	0.1°C ⁶				
Response time (90%)	30ms	150ms		10ms	
Emissivity/gain	0.100 to 1.100 ²				
Transmissivity ¹	0.100 to 1.100				
Signal processing ¹	peak hold, valley hold, average; extended hold function with threshold and hysteresis				
Dimensions of controller	length 35mm; ø12mm				
Outputs/analog	4 to 20mA				
Max. loop resistance	1000Ω ⁷				
Outputs/alarm	0-30V / 500mA (open collector)				
Outputs/digital (optional)	mono-/bidirectional, 9.6kBaud, 0/3V level, alternative USB				
Inputs	programmable functions input for triggered signal output or peak hold function				
LED functions	alarm display, automatic aiming aid, self-diagnostics, temperature display (via temp. code)				
Cable length	1m (standard length); 0.5m between sensor and controller; 0.4m between controller and terminal device				
Power supply	4...20mA (5 to 30VDC)				
Protection class	IP65 (NEMA-4) sensor head				
Ambient temperature	sensor: -20°C to 120°C controller: -20°C to +75°C	sensor: -20°C to 180°C controller: -20°C to +75°C	sensor: -20°C to 125°C controller: -20°C to +75°C		
Storage temperature	-40°C to 85°C (sensor and controller)				
Relative humidity	10 to 95%, non condensing				
Vibration	IEC 68-2-6: 3 G, 11 to 200Hz, any axis				
Shock	IEC 68-2-27: 50 G, 11ms, any axis				
Weight	42g				

¹ adjustable via software

² adjustable via 0 to 5VDC input or software

³ at ambient temperature 23 ±5°C; whichever is greater; object temperature ≥ 0°C

⁴ ε = 1, response time 1s, object temperature > 450°C

⁵ with object temperature < 100°C; time constant of > 0.2s

⁶ with object temperature > 20°C; time constant > 0.2s

⁷ depends on power supply

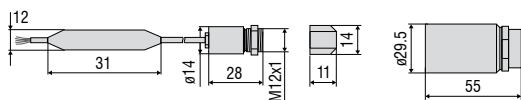

Product identification

CSmi2W -	SF15-	C1
Cable length [1m (standard) / 3m / 8m / 15m]		
Focus [SF / CF]		
thermoMETER CSmi2W (TwoWire)		

Accessories page 54-55

- Ancillary CF lens
- Protective window
- Mounting bracket / Mounting bolt
- Air purge collar
- Right angle mirror
- USB kit

CSLaser

sensor

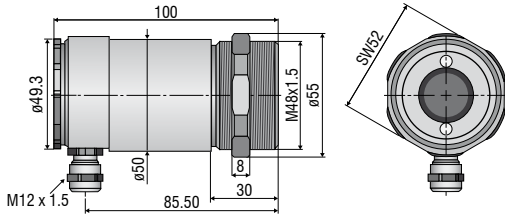

CS

sensor with integrated controller

ancillary CF lens (optional)

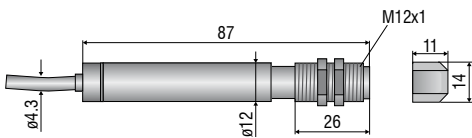

CSmicro / CSmicro 2W

ancillary CF lens (optional)

sensor

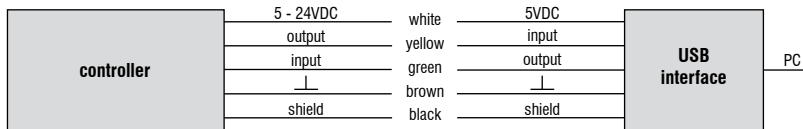
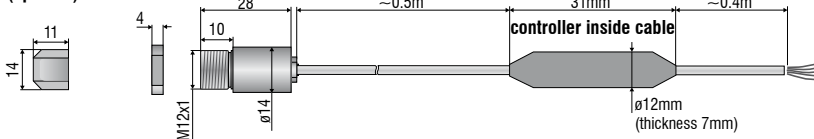

CX

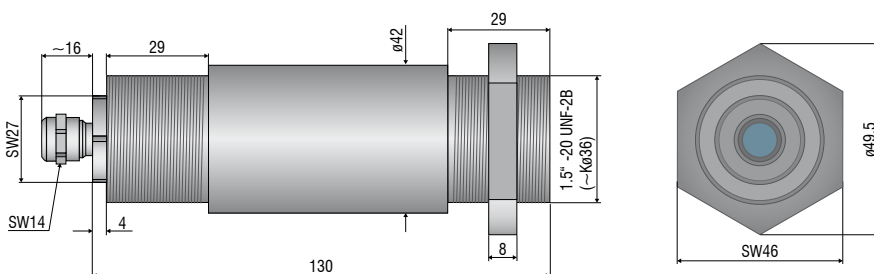

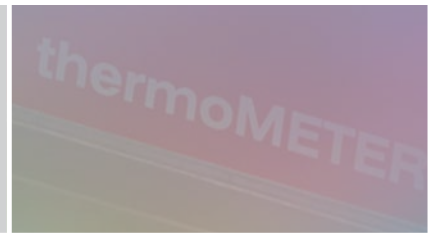

Mechanical accessories CS / CSmicro / CSmicro 2W

Art. No.	Model	Description
2970279	TM-FB-CS	Mounting bracket, fixed
2970280	TM-AB-CS	Mounting bracket, adjustable
2970281	TM-MB-CS	Mounting bolts with M12x1 thread
2970282	TM-MG-CS	Mounting fork, adjustable in 2 axes, with M12x1 fastening
2970283	TM-AP-CS	Air purge collar for 10:1 sensors
2970284	TM-APL-CS	Air purge collar, laminar
2970285	TM-APLCF-CS	Air purge collar, laminar, with integrated ancillary CF lens
2970286	TM-RAM-CS	Right angle mirror for measurements 90° to the sensor axis
2970287	TM-USBK-CS	USB kit: USB programming adapter, software CompactConnect

Optical accessories CS / CSmicro / CSmicro 2W

2970277	TM-CF-CS	Ancillary CF lens for CS models
2970278	TM-PW-CS	Protective window for CS models

Calibration CS / CSmicro / CSmicro 2W

2970288	TM-CERT-CS	Certificate of calibration
---------	------------	----------------------------

Mechanical accessories CX

Art. No.	Model	Description
2970307	TM-AP-CX	Air purge collar, aluminum (anodized)
2970321	TM-FB-CX	Mounting bracket, adjustable in one axis, stainless steel
2970322	TM-AB-CX	Mounting bracket, adjustable, in 2 axes, stainless steel
2970311	TM-USBK-CX	USB kit: USB programming adapter, software CompactConnect

Optical accessories CX

2970302	TM-CF-CX	Ancillary CF lens for CX models
2970303	TM-PW-CX	Protective window for CX models

Calibration CX

2970323	TM-CERT-CX	Certificate of calibration
---------	------------	----------------------------

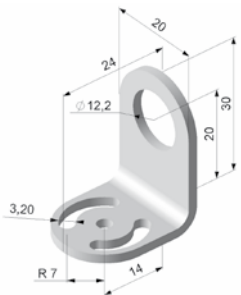

TM-FB-CS Mounting bracket, fixed



TM-MG-CS Mounting fork with M12x1 thread, adjustable in two axes

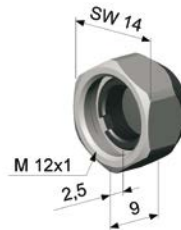

TM-CF-CS Ancillary CF lens (only for LT models)

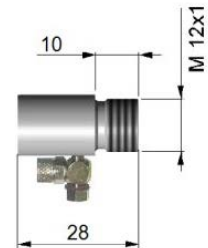

TM-AP-CS Air purge collar for 10:1 sensors

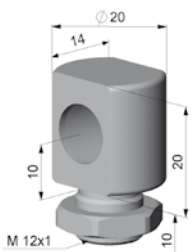

TM-MB-CS Mounting bolts with M12x1 thread adjustable in one axis

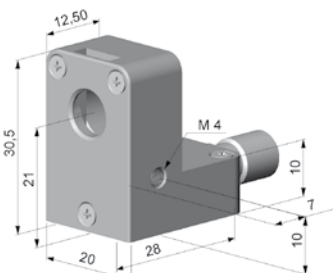

TM-APL-CS Air purge collar, laminar

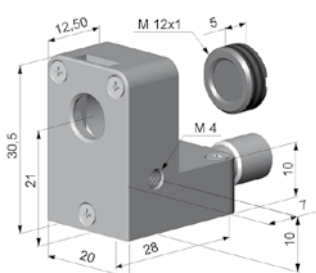

TM-APLCF-CS Air purge collar, laminar with integrated ancillary CF lens



TM-APL-CS Air purge collar, laminar
TM-MG-CS mounting fork



TM-AP-CX Air purge collar for CX sensors

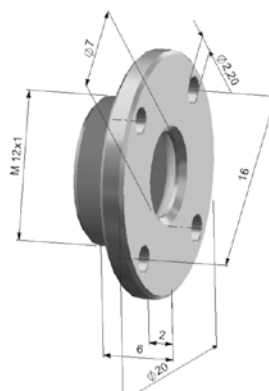

TM-CF-CX Ancillary CF lens, TM-PW-CX protective window

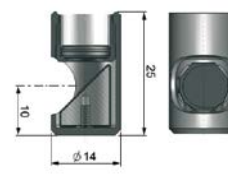

TM-RAM-CS Right angle mirror

Further IR temperature measurement devices from Micro-Epsilon



thermoIMAGER TIM
Compact USB thermal imaging cameras
for precise thermography



thermoMETER CTVideo/CSVVideo
IR temperature sensors with crosshair laser
sighting and video output



thermoMETER Handheld
Innovative handheld pyrometer with laser
sighting for inspection and maintenance