



More Precision

thermoMETER // Non-contact infrared temperature sensors





thermoMETER CSmicro

Miniature OEM infrared temperature sensor with controller integrated in the cable

- Measuring range from -40°C to 1030°C
- Applicable in ambient temperatures up to 120°C without cooling (sensor)
- Robust, silicon-coated lens
- Integrated controller with LED alarm display and intelligent sighting aid, alarm signal, temperature-code display or self-diagnostics
- Integrated controller in the cable
- Scalable analog output and simultaneous alarm output
- Protection against short circuit and polarity change
- Programmable controller
- Optional USB interface and software for programming
- Best price - ideal for OEM applications

Optical specifications thermoMETER CSmicro

□ = smallest spot size / focal point (mm)

Standard Focus											
SF02	2:1	5	53.8	102.5	151.3	200	251.3	302.5	353.8	405	
SF15	15:1	6.5	11.6	16.6	21.7	26.7	35	43.3	51.6	59.9	
	distance in mm	0	100	200	300	400	500	600	700	800	
Close Focus (with optionally available CF lens)											
CF02	2:1	7	6	5	4.1	3.1	2.5	3.3	5.4	7.5	9.5
CF15	15:1	7	3.9	0.8	4.7	8.6	10.9	12.5	16.4	20.3	24.2
	distance in mm	0	5	10	15	20	23	25	30	35	40

Model	CSmi-SF02-C1	CSmi-SF15-C1	CSmiHS-SF15-C4
Optical resolution	2:1	15:1	15:1
Temperature range	-40°C to 1030°C ¹		-20°C to 150°C
Spectral range	8 to 14μm		
System accuracy	±1.0% or ±1.0°C ⁴		
Repeatability	±0.5% or ±0.5°C ³		±0.3% or ±0.3°C ⁴
Temperature coefficient	± 0.05°C/°C or ± 0.05%°C ⁵		
Temperature resolution	0.15°C ⁶		0.025°C ⁶
Response time (90%)	30ms (adjustable up to 999s via optional programming adapter)		150ms (adjustable up to 999s via optional programming adapter)
Emissivity/Gain	0.100 to 1.100 ²		0.100 to 1.100 ¹
Transmissivity/gain ¹	0.100 to 1.100		
Signal processing ¹	peak hold, valley hold, average; extended hold function with threshold and hysteresis		
Dimensions of controller	length 35mm; ø12mm		
Outputs/analog	0 to 5V or 0 to 10V 1/10/100 mV/°C		4 to 20mA
Max. loop resistance	-		1000Ω ⁷
Outputs/alarm	alarm (50mA/ 24V)		0-30V / 500mA (open collector)
Outputs/digital (optional)	mono-/bidirectional, 9.6kBaund, 0/3V level, alternative USB		
Inputs	programmable functional inputs for external emissivity adjustment (0 to 5VDC), hold function or USB communication		programmable functional input for triggered signal output or peak hold function
LED functions	alarm display, automatic aiming aid, self-diagnostics, temperature display (via temp. code)		
Cable length	1m (standard length); 0.5m between sensor and controller; 0.4m between controller and terminal device		4m (0.5m sensor - controller); sensor incl. massive housing TM-MHS-CT (ø29.5mm x 55mm)
Power supply	9mA (5 to 30VDC)		4...20mA (5 to 30VDC)
Protection class	IP65 (NEMA-4) sensor head		
Ambient temperature	sensor: -20°C to 120°C controller: -20°C to 80°C		sensor -20°C to 75°C controller: -20°C to 75°C
Storage temperature	-40°C to 85°C (sensor and controller)		
Relative humidity	10 to 95%, non-condensing		
Vibration	IEC 68-2-6: 3 G, 11 to 200Hz, any axis		
Shock	IEC 68-2-27: 50 G, 11ms, any axis		
Weight	42g		200g

¹ adjustable via software

² adjustable via 0 to 5VDC input or software

³ ambient temperature 23±5°C; whichever is greater; object temperature ≥ 0°C

⁴ ambient temperature 23±5°C; whichever is greater; object temperature >20°C

⁵ with object temperature <100°C; time constant from >0.2s

⁶ with object temperature > 20°C; time constant from >0.2s

⁷ depends on supply voltage

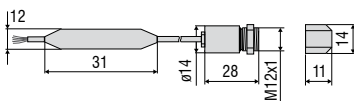

Product identification

CSmi -	SF15-	C1
Cable length [1m (standard) other cable lengths on request]		
Focus [SF / CF]		
thermoMETER CSmicro		

Accessories page 54 - 55

- Ancillary CF lens
- Protective window
- Mounting bracket / mounting bolt
- Air purge collar
- Right angle mirror
- USB kit

CSLaser

sensor

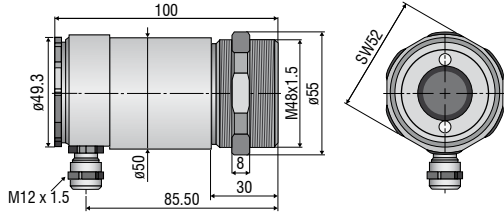

CS

sensor with integrated controller

ancillary CF lens (optional)

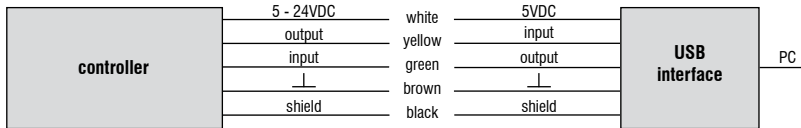
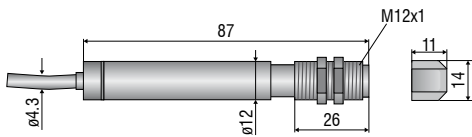

CSmicro / CSmicro 2W

ancillary CF lens (optional)

sensor

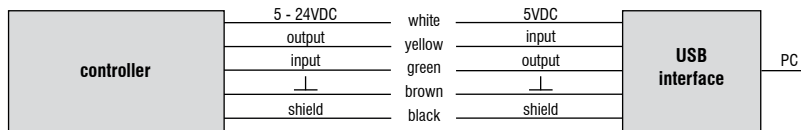
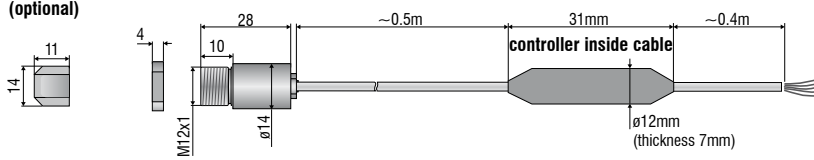

CX

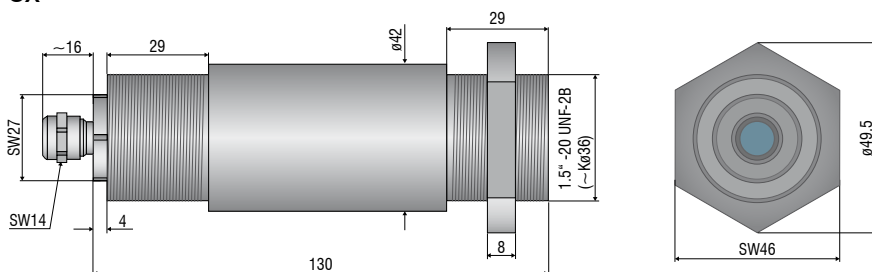

Mechanical accessories CS / CSmicro / CSmicro 2W

Art. No.	Model	
2970279	Emissivity	Mounting bracket, fixed
2970280	TM-AB-CS	Mounting bracket, adjustable
2970281	TM-MB-CS	Mounting bolts with M12x1 thread
2970282	TM-MG-CS	Mounting fork, adjustable in 2 axes, with M12x1 fastening
2970283	TM-AP-CS	Air purge collar for 10:1 sensors
2970284	TM-APL-CS	Air purge collar, laminar
2970285	TM-APLCF-CS	Air purge collar, laminar with integrated ancillary CF lens
2970286	TM-RAM-CS	Right angle mirror for measurements 90°C to the sensor axis
2970287	TM-USBK-CS	USB kit: USB programming adapter, CompactConnect software

Optical accessories CS / CSmicro / CSmicro 2W

2970277	TM-CF-CS	Ancillary CF lens for CS models
2970278	Aluminum	Protective window for CS models

Calibration CS / CSmicro / CSmicro 2W

2970288	TM-CERT-CS	Certificate of calibration
---------	------------	----------------------------

Mechanical accessories CX

Art. No.	Model	
2970307	TM-AP-CX	Air purge collar, aluminum (anodized)
2970321	TM-FB-CX	Mounting bracket, adjustable in 1 axis, stainless steel
2970322	TM-AB-CX	Mounting bracket, adjustable, in 2 axes, stainless steel
2970311	TM-USBK-CX	USB kit: USB programming adapter, CompactConnect software

Optical accessories CX

2970302	TM-CF-CX	Ancillary CF lens for CX models
2970303	TM-PW-CX	Protective window for CX models

Calibration CX

2970323	TM-CERT-CX	Certificate of calibration
---------	------------	----------------------------

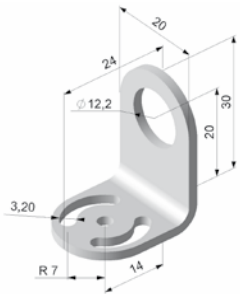

TM-FB-CS mounting bracket, fixed

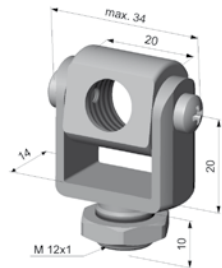

TM-MG-CS Mounting fork with M12x1 thread, adjustable in two axes

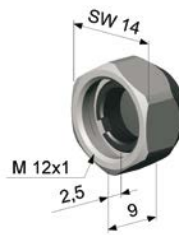

TM-CF-CS Ancillary CF lens (only for LT models)

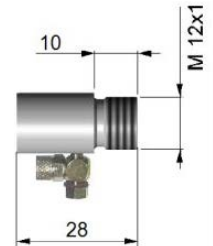

TM-AP-CS Air purge collar for 10:1 sensors

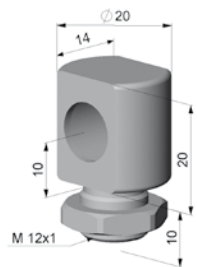

TM-MB-CS Mounting bolts with M12x1 thread adjustable in one axis

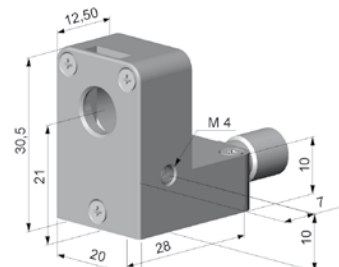

TM-APL-CS Air purge collar, laminar

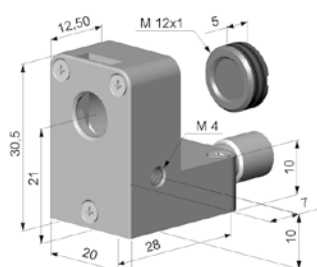

TM-APLCF-CS Air purge collar, laminar with integrated ancillary CF lens



TM-APL-CS Air purge collar, laminar
TM-MG-CS Mounting fork

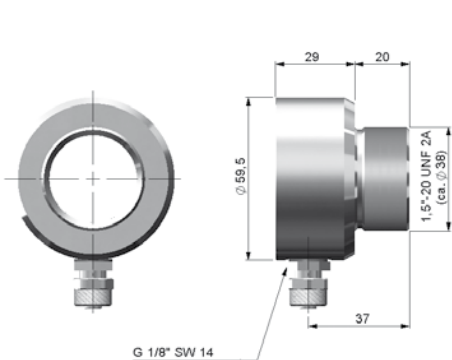

TM-AP-CX Air purge collar for CX sensors

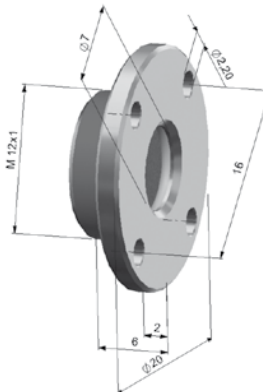

TM-CF-CX Ancillary CF lens, TM-PW-CX Protective window



TM-RAM-CS Right angle mirror

Further IR temperature measurement devices from Micro-Epsilon



thermoIMAGER TIM
Compact USB thermal imaging cameras
for precise thermography



thermoMETER CTVideo/CSVideo
IR temperature sensors with crosshair laser
sighting and video output



thermoMETER Handheld
Innovative handheld pyrometer with laser
sighting for inspection and maintenance