



# More Precision

**optoNCDT** // Laser displacement sensors (triangulation)





Model	ILD1750-2LL	ILD1750-10LL	ILD1750-20LL	ILD1750-50LL
Measuring range	2 mm	10 mm	20 mm	50 mm
Start of measuring range	24 mm	30 mm	40 mm	45 mm
Midrange	25 mm	35 mm	50 mm	70 mm
End of measuring range	26 mm	40 mm	60 mm	95 mm
Linearity	$\leq 1.6 \mu\text{m}$	$\leq 6 \mu\text{m}$	$\leq 12 \mu\text{m}$	$\leq 30 \mu\text{m}$
	$\leq \pm 0.08 \%$ FSO	$\leq 0.06 \%$ FSO		
Repeatability <sup>2)</sup>	0.1 $\mu\text{m}$	0.4 $\mu\text{m}$	0.8 $\mu\text{m}$	2 $\mu\text{m}$
Measuring rate	continuously adjustable 0.3 ... 7.5 kHz			
	6 adjustable stages: 7.5 kHz / 5 kHz / 2.5 kHz / 1.25 kHz / 625 Hz / 300 Hz			
Light source	semiconductor laser <1 mW, 670 nm (red)			
Permissible ambient light with 2.5 kHz	10,000 lx			
Laser safety class	Class 2 in accordance with DIN EN 60825-1 : 2015-07			
Spot diameter	SMR	85 x 240 $\mu\text{m}$	120 x 405 $\mu\text{m}$	185 x 485 $\mu\text{m}$
	MMR	24 x 280 $\mu\text{m}$	35 x 585 $\mu\text{m}$	55 x 700 $\mu\text{m}$
	EMR	64 x 400 $\mu\text{m}$	125 x 835 $\mu\text{m}$	195 x 1200 $\mu\text{m}$
Temperature stability <sup>1)</sup>	0.025 % FSO/°C		0.01 % FSO/°C	
Operating temperature	0 ... +50 °C			
Storage temperature	-20 ... +70 °C			
Control inputs/outputs	1x HTL/TTL Laser on/off; 1x HTL/TTL multifunction input Trigger in / slave in / zero setting / mastering / teach 2x error outputs (error & limit value): npn, pnp, push pull 1x RS422 synchronization input (trigger in, sync in, master/slave, master/slave alternating)			
Measurement value output	analog	4 ... 20 mA; 0 ... 5 V / 0 ... 10 V; 16 bit; freely scalable within the measuring range		
	digital	RS422 / 18bit		
Operation	button	select & function buttons for interface selections, mastering (zero), teach, presets, quality slider, frequency selection, factory settings		
	web interface	application-specific presets; peak selection, video signal; freely selectable averaging possibilities; data reduction; setup management <sup>2)</sup>		
Supply voltage	11 ... 30 VDC			
Power consumption	< 3 W (24 V)			
Sensor cable	standard	0.25 m pigtail with 14-pole ODU connector		
	option	extension: 3 / 10 m		
Synchronization	possible for simultaneous or alternating measurements			
Protection class	IP65			
Vibration	2 g / 20 ... 500 Hz			
Shock	15g / 6 ms			
Weight (with 25 cm cable)	approx. 550 g			

FSO = Full Scale Output; The specified data apply to a white, diffuse reflecting surface (reference: ceramics)

<sup>1)</sup> based on digital output

<sup>2)</sup> Connection to PC via IF2001/USB (optionally available)

SMR = start of measuring range; MMR = midrange; EMR = end of measuring range

**Accessories for all optoNCDT Series****Power supply**

- PS 2020 (power supply 24 V / 2.5 A, input 100 - 240 V AC, output 24 VDC / 2.5 A, mounting onto symmetrical standard rail 35 mm x 7.5 mm, DIN 50022)

**Controller unit for evaluation and signal conversion**

- C-Box/2A (controller for conversion and evaluation of up to 2 sensor signals)

**Interface card**

- IF2008 (interface card for multiple signal processing; analog and digital interfaces)

**USB converter**

- IF2001/USB RS422/USB converter (converter for digital signals in USB)

**USB converter**

- IF2004/USB 4-channel RS422/USB converter (converter for up to 4 digital signals in USB)

**Accessories for optoNCDT 1320 / 1420 / 1402CL1****Supply and output cable (drag-chain suitable)**

- PCF1420-1/I (1 m, output 4...20 mA)
- PCF1420-1/I(01) (1 m, output 4...20 mA)
- PCF1420-3/I (3 m, output 4...20 mA)
- PCF1420-6/I (6 m, output 4...20 mA)
- PCF1420-10/I (10 m, output 4...20 mA)
- PCF1420-15/I (15 m, output 4...20 mA)
- PCF1420-3/U (3 m, with integrated resistor, output 1...5 VDC)\*
- PCF1420-6/U (6 m, with integrated resistor, output 1...5V DC)\*
- PCF1420-10/U (10 m, with integrated resistor, output 1...5 VDC)\*
- PCF1420-15/U (15 m, with integrated resistor, output 1...5 VDC)\*
- PCF1420-3/IF2008 (3 m, interface and supply cable)
- PC1420-6/IF2008 (6 m, supply and output cable)
- PCF1420-10/IF2008 (10 m, interface and supply cable)

\* on request with output 2...10 VDC

**Supply and output cable, suitable for use with robots**

(available in 90° version)

- PCR 1402-3/I (3 m)
- PCR 1402-6/I (6 m)
- PCR 1402-8/I (8 m)

**Accessories for optoNCDT 1610 / 1630****Supply and output cable**

- PC 1605-3 (3 m)
- PC 1605-6 (6 m)
- PC 1607-5/BNC (5 m, BNC connector)

**Accessories for optoNCDT 1750 / 1750LL / 1700BL****Supply and output cable (drag-chain suitable)**

- PC 1700-3 (3 m)
- PC 1700-10 (10 m)
- PC 1700-10/IF2008 (10 m, for use with interface card IF2008)
- PC 1700-3/T (3 m, for use with trigger box)
- PC 1700-10/T (10 m, for use with trigger box)
- PC 1700-3/USB (3 m, with USB-RS422-converter, power supply 90 ... 230 V AC)

**Supply and output cable (suitable for use with robots)**

- PCR 1700-5 (5 m)
- PCR 1700-10 (10 m)

**Supply and output cables for temperatures up to 200 °C**

- PC1700-3/OE/HT (3 m)
- PC1700-6/OE/HT (6 m)
- PC1700-15/OE/HT (15 m)

**Protection housing**

- SGH model (sizes S and M)
- SGHF model (sizes S and M)
- SGHF-HT model

**Accessories for optoNCDT 2300 / 2300LL / 2300BL****Supply and output cable**

- PC2300-0,5Y (connection cable to PC or PLC; for operation a PC2300-3/SUB-D will be required)
- PC2300-3/SUB-D (3 m; for operation a PC2300-0,5Y will be required)
- PC 2300-3/IF2008 (interface and supply cable)
- PC 2300-3/OE (3 m)
- PC 2300-6/OE (6 m)
- PC 2300-9/OE (9 m)
- PC 2300-15/OE (15 m)

\* other cable lengths on request

**Protection housing**

- SGH model (sizes S and M)
- SGHF model (sizes S and M)
- SGHF-HT model

**Supply and output cables for temperatures up to 200 °C**

- PC2300-3/OE/HT (3 m)
- PC2300-6/OE/HT (6 m)
- PC2300-9/OE/HT (9 m)
- PC2300-15/OE/HT (15 m)

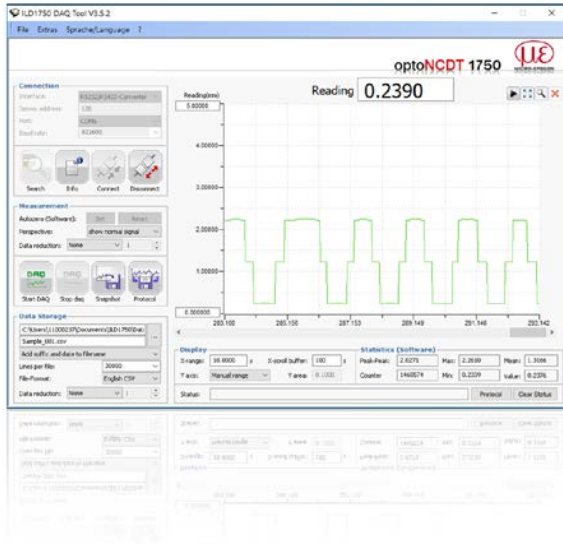

### optoNCDT Demo Tool

The scope of supply includes a software for easy sensor configuration. The settings can be implemented conveniently via a Windows user interface on the PC. The sensor parameters are sent to the sensor via the serial port and can also be saved if required. The software is available as single and multi-channel version. The sensor is connected to the PC via the sensor cable using a USB converter.

### Free download

Download free of charge from [www.micro-epsilon.com/download](http://www.micro-epsilon.com/download): software, driver and well-documented driver DLL for easy sensor integration in existing or customer software.

### Protection housing for harsh environment

To protect the laser sensors in extreme environments, individual protective housings are available for all sensor models. There are three different models:

#### SGH model:

Completely enclosed housing with an integrated front window, where the sensor measures through the window. The water-resistant housing provides protection against solvents and detergents.

#### SGHF model:

With window and compressed-air connection ideal for high ambient temperatures. The integrated air cooling of the housing offers optimum protection for the sensor.

#### SGHF-HT model

This water-cooled protection housing with window and compressed-air connection is designed for measurement tasks in ambient temperatures up to 200 °C.

Suitable for all long-range sensors

optoNCDT 1710

optoNCDT 1750-500 and optoNCDT 1750-750

optoNCDT 2310

optoNCDT 2300 - 200

Maximum ambient temperature 200 °C

Maximum cooling water temperature  $T(\max) = 10\text{ °C}$

Minimum water flow rate  $Q(\min) = 3\text{ liters/min}$



**SGHx ILD size S (140x140x71mm)**  
for optoNCDT 1750 / 2300 dimensions 97 x 75 mm

**SGHx ILD size M (140x180x71mm)**  
for optoNCDT 1750 / 2300 dimensions 150 x 80 mm



### IF2008 - PCI interface card

The IF2008 interface card is designed for installation in PCs and enables the synchronous capture of four digital sensor signals and two encoders. The IF2008E expansion board enables the acquisition of two digital sensor signals, two analog sensor signals and eight I/O signals. The absolutely synchronous data acquisition plays an important role particularly for planarity or thickness measurement tasks. The data are stored in a FIFO memory in order to enable resource-saving processing in the PC in blocks.

#### Special features

- 4x digital signals and 2x encoders with IF2008 basic PCB
- 2x digital signals, 2x analog signals and 8x I/O signals with IF2008E expansion board
- Additional expansion board for a total of 6x digital signals, 2x encoders, 2x analog signals and 8x I/O signals
- FIFO data memory
- Synchronous data acquisition

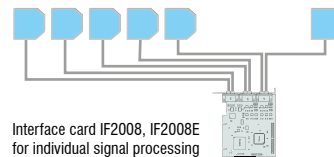

Interface card IF2008, IF2008E  
for individual signal processing

### IF2001/USB converter RS422 to USB

The RS422/USB converter transforms digital signals from a laser-optical sensor into a USB data packet. The sensor and the converter are connected via the RS422 interface of the converter. Data output is done via USB interface. The converter loops through further signals and features such as laser on/off, switch signals and function output. The connected sensors and the converter can be programmed through software.



**IF2004/USB: 4-channel converter from RS422 to USB**

The RS422/USB converter is used for transforming digital signals from up to four optical sensors into USB data signals. The converter has four trigger inputs and a trigger output for connecting additional converters. Data is output via an USB interface. The connected sensors and the converter can be programmed through software.

**Special features**

- 4x digital signals via RS422
- 4x trigger inputs, 1x trigger output
- Synchronous data acquisition
- Data output via USB



**C-Box/2A controller for conversion and evaluation of up to two sensor signals**

C-Box/2A is used for fast D/A conversion of two digital input signals or for evaluating two digital sensor signals. The controller is compatible with the optoNCDT 2300 laser triangulation sensors. Output of the sensor signals is possible via two configurable analog outputs, Ethernet or USB. Handling of the C-Box/2A and of the connected sensors are performed via web interface. Averaging functions, thickness, diameter, step and inclinations can be calculated. The D/A conversion is executed at 16Bit and max. 70kHz.



## High performance sensors made by Micro-Epsilon



Sensors and systems for displacement and position



Sensors and measurement devices for non-contact temperature measurement



2D/3D profile sensors (laser scanner)



Optical micrometers, fiber optic sensors and fiber optics



Color recognition sensors, LED analyzers and color inline spectrometer



Measurement and inspection systems