



More Precision

induSENSOR // Linear inductive displacement sensors





- Proven LVDT technology
- Measuring ranges $\pm 1 \dots \pm 10 \text{ mm}$
- Low cost especially for high volume applications
- Sensor diameter of just $\varnothing 8\text{mm}$
- Models with pneumatic push

LVDT gauging sensors DTA-xG8 are primarily used for the measurement and inspection of workpiece geometry (length, width, diameter, thickness, depth, height). They are ideally suitable for high volume applications.

These gauges have an axial cable output and are equipped with either a plain bearing-guided plunger and spring, or with a pneumatic push rod.

Probe tips

Standard: type 2

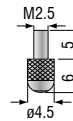

Option: type 11



Option: type 13

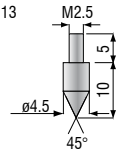

Article designation

DT	A-	5-	G8-	3-	CA-	V
Principle: Differential Transformer (LVDT)						
Excitation AC						
Measuring range in mm						
Function: gauging sensor						
Linearity: 3 ($\pm 0.3\%$)						
Connection (axial): CA integral cable (3m)						
Gauging sensor options: V: pneumatic push						

Model	DTA-1G8	DTA-3G8	DTA-5G8	DTA-10G8	DTA-1G8-V	DTA-3G8-V	DTA-5G8-V	DTA-10G8-V
Measuring range	± 1 mm	± 3 mm	± 5 mm	± 10 mm	± 1 mm	± 3 mm	± 5 mm	± 10 mm
Linearity	0.3 % FSO							
Repeatability	0.15 μm	0.45 μm	0.75 μm	1.5 μm	0.15 μm	0.45 μm	0.75 μm	1.5 μm
Temperature stability	250 ppm/°C							
Temperature range	-20...+80 °C (without bellows) / 0...+80 °C (with bellows)							
Diameter	8h9 mm							
Sensor material	stainless steel / FPM							
Connection / pin connector	open ends							
Protection class (sensor)	IP65 (with bellows) / IP54 (without bellows)							
Cable output	axial							
Cable length (sensor)	3 m							
Life cycle MTBF	5 million cycles							
Sensitivity	133 mV/mm/V	85 mV/mm/V	53 mV/mm/V	44 mV/mm/V	133 mV/mm/V	85 mV/mm/V	53 mV/mm/V	44 mV/mm/V
Suitable controller	MSC7401 (pages 10 - 11)							

FSO = Full Scale

DTA-xG8-3-CA

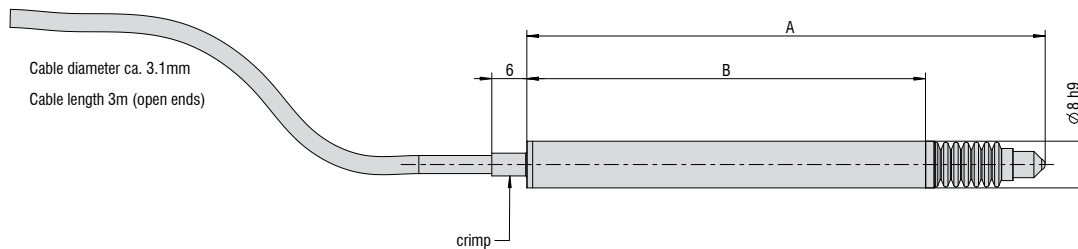

Model	A (zero position)	B
DTA-1G8-3-CA	83 mm	64.3 mm
DTA-3G8-3-CA	89 mm	68.3 mm
DTA-5G8-3-CA	118 mm	89.5 mm
DTA-10G8-3-CA	155 mm	121.7 mm

DTA-xG8-3-CA-V

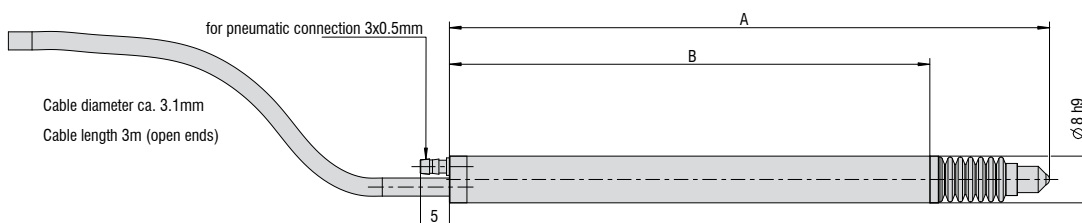

Model	A (zero position)	B
DTA-1G8-3-CA-V	95 mm	76.3 mm
DTA-3G8-3-CA-V	103 mm	82.3 mm
DTA-5G8-3-CA-V	134 mm	105.3 mm
DTA-10G8-3-CA-V	170.8 mm	137.3 mm

General accessories

2960031	MC25D	Digital micrometer calibration fixture
2420062	PS2020	Power supply on DIN rail, input 100 - 240 VAC, output 24 VDC / 2.5 A
2984026		Function and linearity inspection certificate incl. protocol with listed measurement data of the linearity inspection and documentation
2213034		IF7001 single-channel USB/RS485 converter

Accessories for LDR series**Connection cables**

0157047	C7210-5/3	Sensor cable, 5 m, with cable connector
0157048	C7210/90-5/3	Sensor cable, 5 m, with 90° cable connector

Supply cable

2901087	PC710-6/4	Supply/output cable, 6 m
---------	-----------	--------------------------

Spare plungers

0800136	LDR-10	Spare plunger
0800137	LDR-25	Spare plunger
0800138	LDR-50	Spare plunger

Service

Connector installation and adjustment

Accessories for EDS series**Service**

2985001		Function and linearity inspection for EDS series incl. pressure inspection and documentation without recalibration
---------	--	---

Connection cables

0157043	C703-5	VIP/LVP/EDS 7-pin connection cable for S series, 5 m
2902084	C703-5/U	VIP/LVP/EDS 7-pin connection cable for S series, 5 m for voltage output 1 - 5 V
0157050	C703/90-5	VIP/LVP/EDS 7-pin connection cable for S series, 5 m with 90° cable connector
2901143	C705-5	VIP/LVP/EDS 5-pin connection cable for F series, 5 m
2901160	C705-15	VIP/LVP/EDS 5-pin connection cable for F series, 15 m

Installation ring

0483326	EDS mounting ring
---------	-------------------

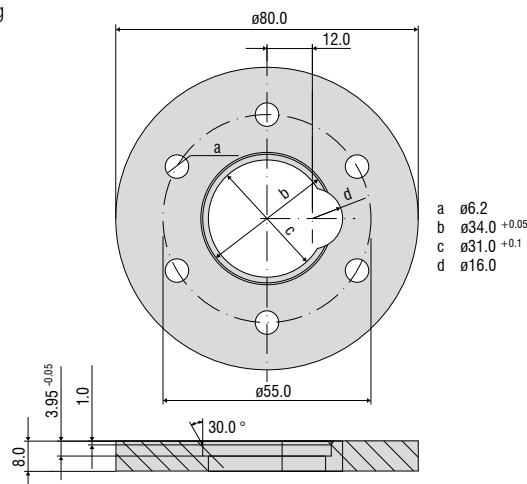

Linearity inspection certificate

Accessories for LVDT series

Sensor cables

2902004	C701-3	Sensor cable, 3 m, with cable connector and tin-plated free ends
2902013	C701-6	Sensor cable, 6 m, with cable connector and tin-plated free ends
2902009	C701/90-3	Sensor cable, 3 m, with 90° cable connector and tin-plated free ends
2213034	IF7001	Single-channel USB/RS485 converter for MSC7xxx

Service

2981010	Connector installation and calibration
---------	--

Connection cables

2901087	PC710-6/4	Supply/output cable, 6 m, open ends
29011154	PC5/5-IWT	Supply/output cable, 5 m, open ends/M12

Spare plungers

0800001	DTA-1D	Spare plunger
0800002	DTA-3D	Spare plunger
0800003	DTA-5D	Spare plunger
0800004	DTA-10D	Spare plunger
0800005	DTA-15D	Spare plunger
0800006	DTA-25D	Spare plunger

Flanges

0483090.01	DTA-F10	Mounting flange, slotted for DTA-1D, DTA-3D, DTA-5D, DTA-10D
0483083.02	DTA-F20	Mounting flange, slotted for DTA-15D, DTA-25D

Probe tips

0459002	Type 2
0459001	Type 2 (hard metal)
0459003	Type 11
0459004	Type 13

Flange DTA-F10

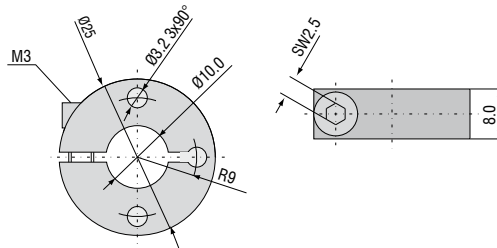

Flange DTA-F20

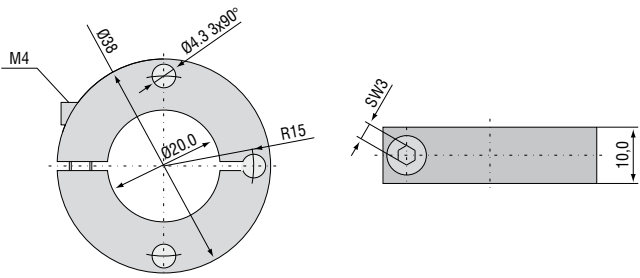

Standard probe tip: type 2

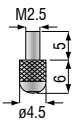

Option: type 11

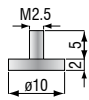

Option: type 13

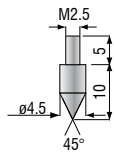

High performance sensors made by Micro-Epsilon



Sensors and systems for displacement and position



Sensors and measurement devices for non-contact temperature measurement



2D/3D profile sensors (laser scanner)



Optical micrometers, fiber optic sensors and fiber optics



Color recognition sensors, LED analyzers and color inline spectrometer



Measurement and inspection systems