

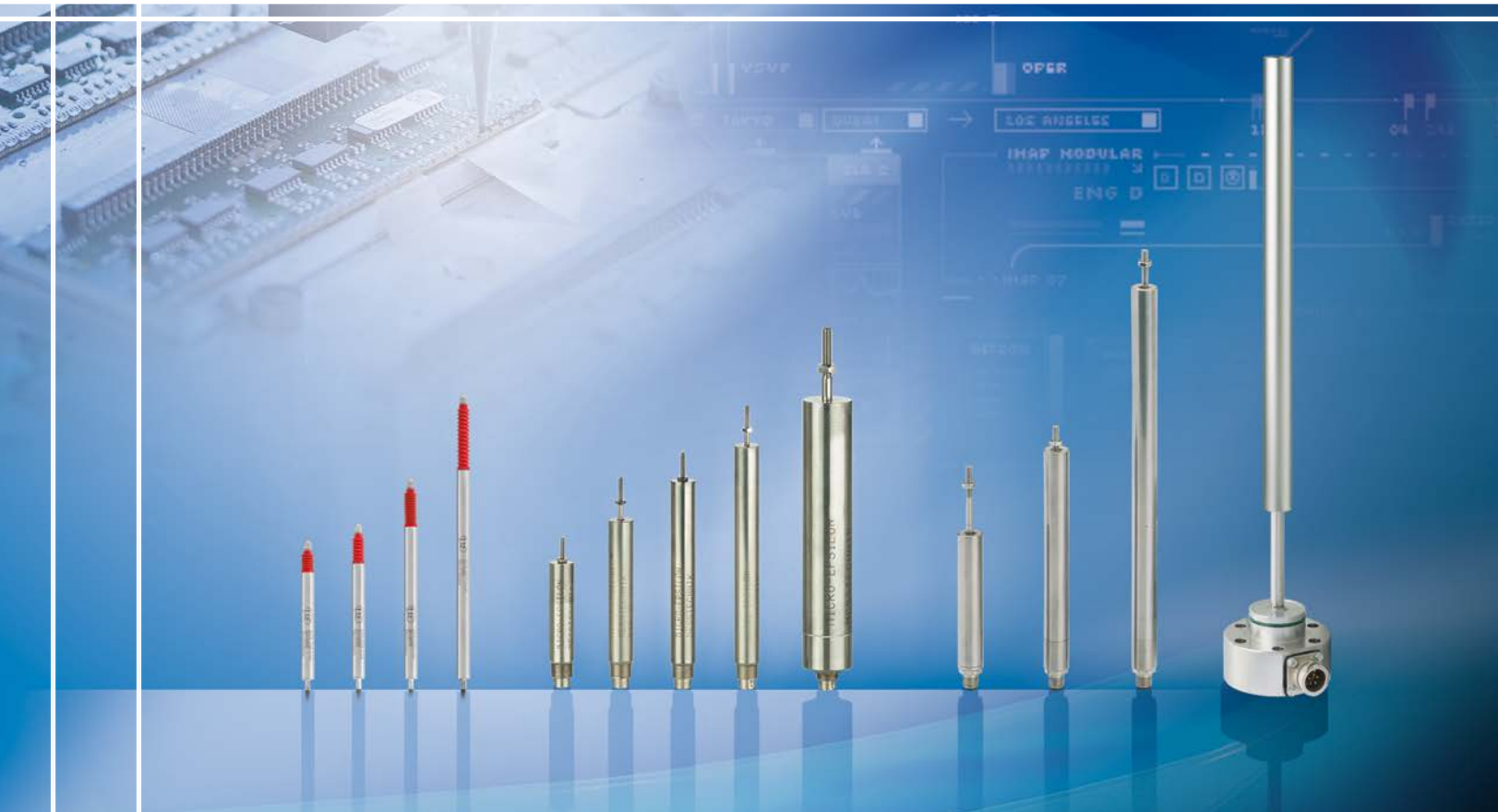

More Precision

induSENSOR // Linear inductive displacement sensors





- Proven LVDT technology
- Measuring ranges $\pm 1 \dots \pm 25\text{mm}$
- Extremely accurate also under difficult ambient conditions
- Long-term stability
- Wear-free

LVDT displacement sensors have a plunger which moves freely in the sensor housing. The plunger is joined to the object by a thread to transfer the movement of the measurement object. The measurement process in the sensor takes place without contact and is therefore wear-free. The displacement sensors are mainly used to measure and monitor movements, displacements, positions, strokes, deflections, dislocations, etc. in vehicles, machines and systems.

The high sensor resolution is limited only by the noise in the sensor electronics. A further advantage of the symmetrically constructed sensors in the LVDT series is the zeropoint stability of the systems. The sensors are supplied with an excitation frequency of 1 to 5 kHz depending on the measurement range and an excitation amplitude of 2.5 to 5V_{eff}. Matched sensor electronics are available in this respect. With appropriate setting possibilities for the excitation frequency and amplitude, the sensors can also be operated with alternative electronics.

Article

DT	A-	10-	D-	3-	CA-	W
Options:						
W welded/sealed housing (water proof up to 5bars)						
P pressure resistant housing (up to 100bar)						
F pressure resistant mounting flange O-ring seal						
H high temperature sensor up to 200°C with integral teflon cable (only for connection types -CA/-CR)						
Connection axial			Connection radial			
CA integral cable (3m)			CR integral cable (3m)			
SA plug connection			SR plug connection			
Linearity: 5 ($\pm 0.5\%$)		3 ($\pm 0.3\%$)		1,5 ($\pm 0.15\%$)		
Function: displacement sensor						
Measuring range \pm mm						
Excitation AC						
Principle: differential transformer (LVDT)						

Model	DTA-1D-		DTA-3D-		DTA-5D-		DTA-10D-		DTA-15D-				DTA-25D-			
	CA	SA	CA	SA	CA	SA	CA	SA	CA	CR	SA	SR	CA	CR	SA	SR
Connection	CA SA		CA SA		CA SA		CA SA		CA CR SA SR				CA CR SA SR			
Measuring range	±1mm		±3mm		±5mm		±10mm		±15mm				±25mm			
Linearity	standard ≤0.5%		-		-		-		-				300 μm			
	standard ≤0.3%		6μm		18μm		30μm		60μm		90μm		150μm			
	optional ≤0.15%		3μm		9μm		15μm		30μm		45μm		-			
Excitation frequency	5kHz				2kHz				1kHz							
Excitation amplitude	5V _{eff}								2.5V _{eff}							
Sensitivity	133mV/Vmm		85mV/Vmm		53mV/Vmm		44mV/Vmm		45mV/Vmm				33mV/Vmm			
Temperature range	-20°C...80°C															
Storage temperature	-40°C ... +80°C / +120°C															
Temperature stability	zero ±50ppm/°C															
	sensitivity ±100ppm/°C															
Housing	stainless steel including magnetic shielding															
Minimum cable bending radius	20mm															
Outer diameter cable	~4.6mm															
Protection class	IP 67															
Shock	40g, 1000 shocks / axis															
	100g, 3 shocks / direction															
Vibration	10Hz ... 58Hz ±1.5mm / 58Hz ... 500Hz ±20g															
Electronics	MSC710 (page 8 - 9)															

F50 = Full Scale Output

Sensor types with measuring range up to ±10mm (inner diameter ø2.7mm)

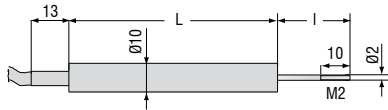

Type-CA with integral cable

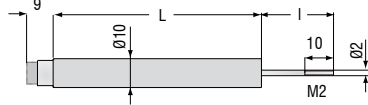

Type-SA with axial plug connection

Sensor types with measuring range ±15mm and ±25mm (inner diameter ø4.8 mm)

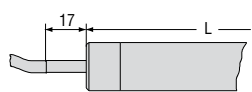

Type - CA
with integral cable

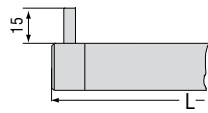

Type - CR
with integral cable (radial)

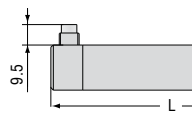

Type - SR
with radial plug connection

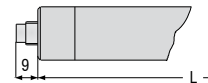

Type - SA
with axial plug connection

Basic model	DTA-1D-		DTA-3D-		DTA-5D-		DTA-10D-		DTA-15D-				DTA-25D-			
Connection	CA	SA	CA	SA	CA	SA	CA	SA	CA	CR	SA	SR	CA	CR	SA	SR
Length of housing L	40mm	40mm	57mm	57mm	73mm	73mm	87mm	87mm	106.5mm				143.5mm			
Length of plunger l ¹⁾	19mm		29mm		30mm		35mm		51mm				62mm			
Housing diameter	10mm								20mm							

¹⁾ Plunger in zero position (±10% of measuring range ±1 mm)

Female connector 90°
dimensions apply
for all models

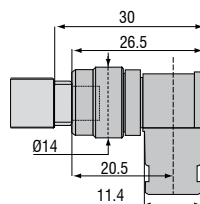

Female connector 90°
dimensions apply
for all models

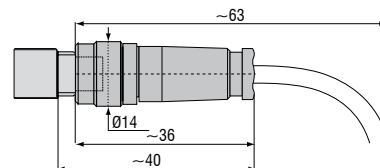



- Excellent linearity and resolution
- Zero and gain adjustable coarse/fine
- Excitation frequency 1 ... 10kHz (selectable)
- Compact and robust EMI-proofed housing

The MSC710 is a single-channel miniature sensor controller for the operation of inductive displacement sensors based on the LVDT principle (Linear Variable Differential Transformer). Its compact, but rugged design, makes it suitable for both industrial and laboratory applications.

Easily accessible and simple to operate, by using DIP-switches. The electronic unit can be matched to a wide range of sensors.

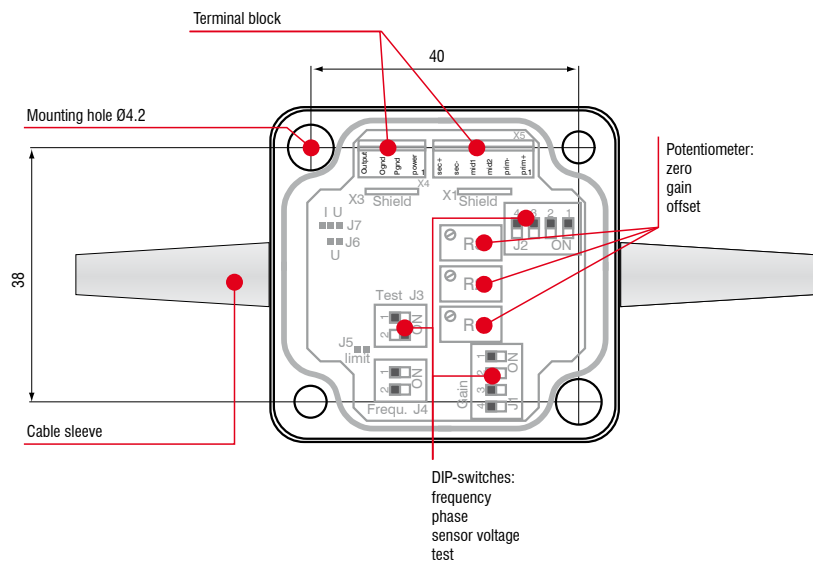
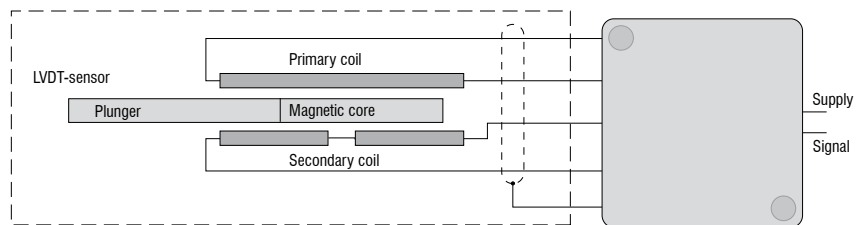

Housing dimensions 52 x 50 x 35mm

Model		MSC710-U	MSC710-I
Power supply		18 ... 30 VDC (18 ... 45mA)	
Protection		Reverse polarity protection, overvoltage protection	
Sensor principle		for LVDT sensors	
Sensor excitation		150 ... 400mV	
		1/2/5kHz (selectable by DIP-switches)	
Input impedance	sensor	10kOhm	
Range	gain	-20 ... +350% (trimpot)	
	zero	±50% (trimpot)	
Output signal		2 ... 10 VDC ($R_a > 1k\Omega$)	4 ... 20mA (load <500Ohm)
Noise		< 1.5mV _{eff} *	< 3μA _{eff} *
		< 15mV _{ss}	< 30μA _{ss}
Linearity		<0.02% FSO	
Frequency response		300Hz (-3dB)	
Temperature range	storage	-40°C ... +85°C	
	operating	0°C ... +70°C	
Temperature stability		±100ppm / °C	
Protection class		IP 65	
Weight		80g	
Housing material		ABS-plastic	
Electromagnetic compatibility (EMC)		EN 61326-1:2006 (spurious emission)	
		EN 61326-2-3:2006 (immunity to interference)	
Vibration		EN 60068-2-64 (noise)	
Shock		EN 60068-2-29 (continuous shock)	

FSO = Full Scale Output

* RMS AC-Measuring, Frequency 3 Hz ... 300 Hz

General accessories

2960031	MC25D	digital micrometer calibration fixture
2420062	PS2020	power supply on DIN rail, input 100 - 240VAC, output 24VDC / 2.5A
2984026		certificate function and linearity inspection certificate incl. protocol with listed measurement data of the linearity inspection and documentation

AccessoriesLDR series**Connection cable**

0157047	C7210-5/3	sensor cable, 5m, with cable connector
0157048	C7210/90-5/3	sensor cable, 5m, with 90° cable connector

Supply cable

2901087	PC710-6/4	supply/output cable, 6m
---------	-----------	-------------------------

Plunger

0800136	LDR-10	plunger
0800137	LDR-25	plunger
0800138	LDR-50	plunger

AccessoriesEDS series**Service**

2985001		Function and linearity inspection for EDS series incl. pressure inspection and documentation without recalibration
---------	--	---

Connection cable

0157043	C703-5	VIP/LVP/EDS 7-pin connection cable for S series, 5m
2902084	C703-5/U	VIP/LVP/EDS 7-pin connection cable for S series, 5m for voltage output 1 - 5V
0157050	C703/90-5	VIP/LVP/EDS 7-pin connection cable for S series, 5m with 90° cable connector
2901143	C705-5	VIP-/LVP-/EDS -pin connection cable for F series, 5m
2901160	C705-15	VIP-/LVP-/EDS -pin connection cable for F series, 15m



Linearity inspection certificate

Accessories LVDT series

Sensor cable

2902004	C701-3	sensor cable 3m, with connector and tin-plated free ends
2902013	C701-6	sensor cable, 6m, with connector and tin-plated free ends
2902009	C701/90-3	sensor cable, 3m, with 90° connector and tin-plated free ends
2966002	MSC710	connector set for supply/output cable
2981010		connector mounting and calibration of MSC710

Connection cable

2901087	PC710-6/4	supply/output cable, 6 m
---------	-----------	--------------------------

Plunger

0800001	DTA-1D	plunger
0800002	DTA-3D	plunger
0800003	DTA-5D	plunger
0800004	DTA-10D	plunger
0800005	DTA-15D	plunger
0800006	DTA-25D	plunger

Flange

0483090.01	DTA-F10	mounting flange, slotted for DTA-1D, DTA-3D, DTA-5D, DTA-10D
0483083.02	DTA-F20	mounting flange, slotted for DTA-15D, DTA-25D

Probe tips

0459002	type 2
0459001	type 2 hard metall
0459003	type 11
0459004	type 13

Flange DTA-F10

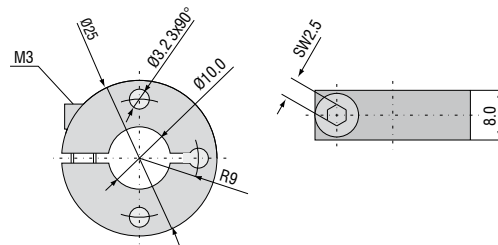

Flange DTA-F20

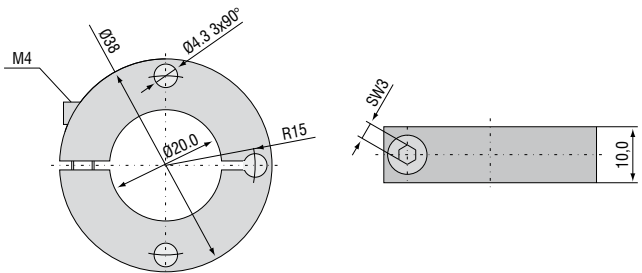

Standard probe tip: type 2 Option: type 11 Option: type 13

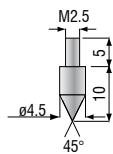
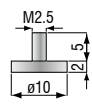
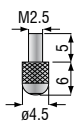

High performance sensors made by Micro-Epsilon



Sensors and systems for displacement and position



Sensors and measurement devices for non-contact temperature measurement



2D/3D profile sensors (laser scanner)



Optical micrometers, fiber optic sensors and fiber optics



Color recognition sensors, LED analyzers and color online spectrometer



Measurement and inspection systems