

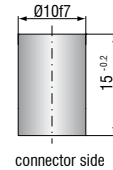

More Precision

capa**NCDT** // Capacitive displacement sensors and systems

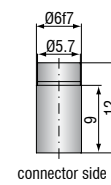

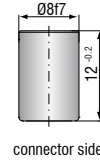
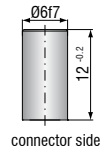
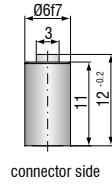

Sensor type		CS005	CS02	CS05	CSE05	CS08
Article No.		6610083	6610051	6610053	6610102	6610080
Measuring range	reduced	0.025mm	0.1mm	0.25mm	0.25mm	0.4mm
	nominal	0.05mm	0.2mm	0.5mm	0.5mm	0.8mm
	extended	0.1mm	0.4mm	1mm	1mm	1.6mm
Linearity ¹⁾		≤ 0.15µm	≤ 0.4µm	≤ 0.15µm	≤ 0.15µm	≤ 0.4µm
		≤ 0.3% FSO	≤ 0.2% FSO	≤ 0.03% FSO	≤ 0.03% FSO	≤ 0.2% FSO
Resolution ¹⁾	static 2Hz	0.0375nm	0.15nm	0.375nm	0.375nm	0.6nm
	dynamic 8.5kHz	1nm	4nm	10nm	10nm	16nm
Temperature stability	Zero ⁴⁾	-60nm/K	-60nm/K	-60nm/K	-60nm/K	-60nm/K
	Sensitivity	-0.5nm/K	-2nm/K	-5nm/K	-5nm/K	-8nm/K
Temperature range	Operation	-50 ... +200°C	-50 ... +200°C	-50 ... +200°C	-50 ... +200°C	-50 ... +200°C
	Storage	-50 ... +200°C	-50 ... +200°C	-50 ... +200°C	-50 ... +200°C	-50 ... +200°C
Humidity ²⁾		0% ... 95% r.H.	0% ... 95% r.H.	0% ... 95% r.H.	0% ... 95% r.H.	0% ... 95% r.H.
Dimensions		Ø6 × 12mm	Ø6 × 12mm	Ø8 × 12mm	Ø6 × 12mm	Ø10 × 15mm
Active measuring area		Ø1.3mm	Ø2.3mm	Ø3.9mm	Ø3.9mm	Ø4.9mm
Guard ring width		0.8mm	1mm	1.4mm	0.8mm	1.6mm
Minimum target diameter		Ø3mm	Ø5mm	Ø7mm	Ø6mm	Ø9mm
Weight		2g	2g	4g	2g	7g
Material	Housing	NiFe ³⁾ (magn.)	NiFe (magn.)	NiFe (magn.)	NiFe (magn.)	NiFe (magn.)
Connection		type C	type C	type C	type C	type C
Mounting		clamping	clamping	clamping	clamping	clamping

FSO = Full Scale Output

¹⁾ Valid with reference controller, relates to standard measuring range

²⁾ Non condensing

³⁾ Titanium version available

⁴⁾ Sensor mounted in the mid of clamping area

Sensors

The sensors are designed as guard ring capacitors. They are connected to the signal conditioning electronics with a triaxial cable. The sensor cable is connected to the sensor using a high quality connector. All standard sensors can be used within a maximum deviation of 0.3% without recalibration. Individually matched special sensors are produced on request.

Measuring range expansion/reduction

The capaNCDT controller can optionally be configured so that the standard measuring ranges of the sensors are reduced by half or expanded by the factor of 2. The reduction increases the accuracy while the measuring range expansion reduces the accuracy.

Connector type C

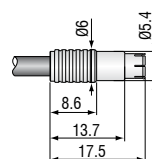

Connector type C/90

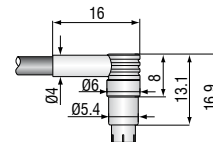

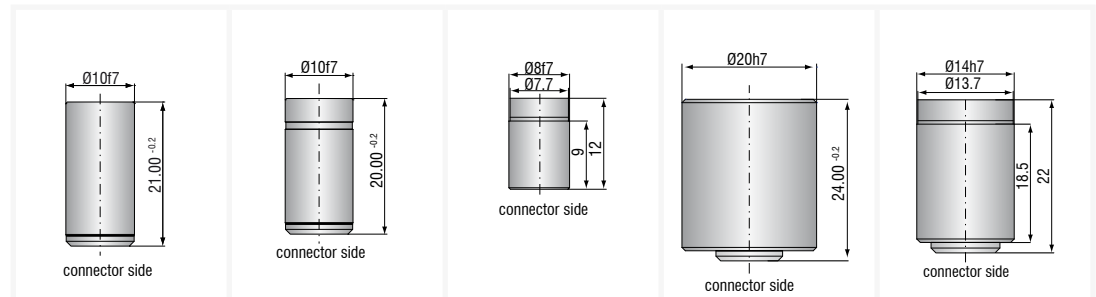

Sensor type		CS1t	CS1HP	CSE1	CS2	CSE2
Article No.		6610054	6610074	6610103	6610052	6610104
Measuring range	reduced	0.5mm	0.5mm	0.5mm	1mm	1mm
	nominal	1mm	1mm	1mm	2mm	2mm
	extended	2mm	2mm	2mm	4mm	4mm
Linearity ¹⁾		≤ 1.5µm	≤ 1.5µm	≤ 2µm	≤ 1µm	≤ 2.6µm
		≤ 0.15% FSO	≤ 0.15% FSO	≤ 0.2% FSO	≤ 0.05% FSO	≤ 0.13% FSO
Resolution ¹⁾	static 2Hz	0.75nm	0.75nm	0.75nm	1.5nm	1.5nm
	dynamic 8.5kHz	20nm	20nm	20nm	40nm	40nm
Temperature stability	Zero ⁴⁾	-170nm/K	-60nm/K	-60nm/K	-170nm/K	-170nm/K
	Sensitivity	-32nm/K	-10nm/K	-10nm/K	-64nm/K	-64nm/K
Temperature range	Operation	-50 ... +200°C	-50 ... +200°C	-50 ... +200°C	-50 ... +200°C	-50 ... +200°C
	Storage	-50... +200°C	-50 ... +200°C	-50 ... +200°C	-50 ... +200°C	-50 ... +200°C
Humidity ²⁾		0% ... 95% r.H.	0% ... 95% r.H.	0% ... 95% r.H.	0% ... 95% r.H.	0% ... 95% r.H.
Dimensions		Ø10 × 21mm	Ø10 × 20mm	Ø8 × 12mm	Ø20 × 24mm	Ø14 × 22mm
Active measuring area		Ø5.7	Ø5.7mm	Ø5.7mm	Ø7.9mm	Ø8.0mm
Guard ring width		1.5mm	1.5mm	0.9mm	4.4mm	2.7mm
Minimum target diameter		Ø9mm	Ø9mm	Ø8mm	Ø17mm	Ø14mm
Weight		8g	8g	3.5g	50g	20g
Material	Housing	1.4404 ³⁾ (non-magn.)	NiFe (magn.)	NiFe (magn.)	1.4404 ³⁾ (non-magn.)	1.4404 (non-magn.)
Connection		type B	type B	type C	type B	type B
Mounting		clamping	clamping	clamping	clamping	clamping

FSO = Full Scale Output

¹⁾ Valid with reference controller, relates to standard measuring range

²⁾ Non condensing

³⁾ Titanium version available

⁴⁾ Sensor mounted in the mid of clamping area

Mounting cylindrical sensors

All sensors can be installed as both freestanding and flush units. The sensors can be clamped or fastened using a collet.

Connector type B

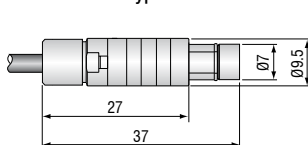

Connector type B/90

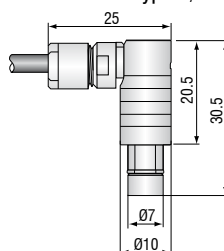

Mounting with grub screw (plastic)

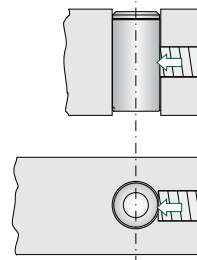

Mounting with collet

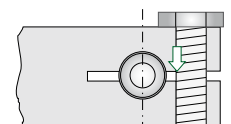

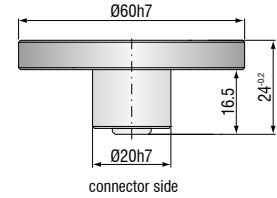
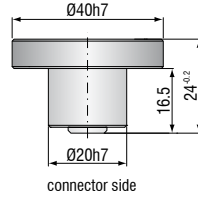
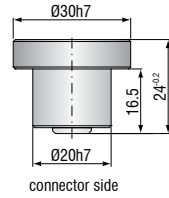

Sensor type		CS3	CS5	CS10
Article No.		6610055	6610056	6610057
Measuring range	reduced	1.5mm	2.5mm	5mm
	nominal	3mm	5mm	10mm
	extended	6mm	10mm	20mm
Linearity ¹⁾		≤ 0.9µm	≤ 2.5µm	≤ 15µm
		≤ 0.03% FSO	≤ 0.05% FSO	≤ 0.15% FSO
Resolution ¹⁾	static 2Hz	2.25nm	3.75nm	7.5nm
	dynamic 8.5kHz	60nm	100nm	200nm
Temperature stability	Zero ⁴⁾	-170nm/K	-170nm/K	-170nm/K
	Sensitivity	-96nm/K	-160nm/K	-320nm/K
Temperature range	Operation	-50 ... +200°C	-50 ... +200°C	-50 ... +200°C
	Storage	-50 ... +200°C	-50 ... +200°C	-50 ... +200°C
Humidity ²⁾		0% ... 95% r.H.	0% ... 95% r.H.	0% ... 95% r.H.
Dimensions		Ø30 × 24mm	Ø40 × 24mm	Ø60 × 24mm
Active measuring area		Ø9.8mm	Ø12.6mm	Ø17.8mm
Guard ring width		8mm	11.6mm	19mm
Minimum target diameter		Ø27mm	Ø37mm	Ø57mm
Weight		70g	95g	180g
Material	Housing	1.4404 (non-magn.)	1.4404 ³⁾ (non-magn.)	1.4404 ³⁾ (non-magn.)
Connection		type B	type B	type B
Mounting		clamping	clamping	clamping

FSO = Full Scale Output

¹⁾ Valid with reference controller, relates to standard measuring range

²⁾ Non condensing

³⁾ Titanium version available

⁴⁾ Sensor mounted in the mid of clamping area

Connector type B

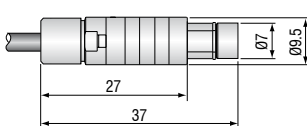

Connector type B/90

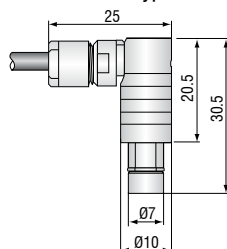

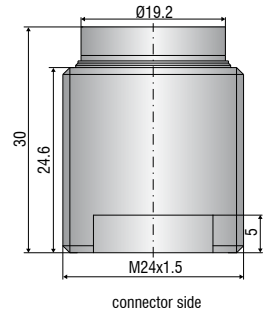
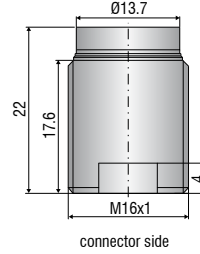
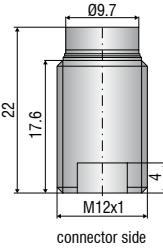
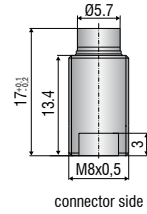

Sensor type		CSE05/M8	CSE1,25/M12	CSE2/M16	CSE3/M24
Article No.		6610172	6610160	6610167	6610171
Measuring range	reduced	0.25mm	0.625mm	1mm	1.5mm
	nominal	0.5mm	1.25mm	2mm	3mm
	extended	1mm	2.5mm	4mm	6mm
Linearity ¹⁾		≤ 0.15µm	≤ 1.25µm	≤ 2µm	≤ 3µm
		≤ 0.03% FSO	≤ 0.1% FSO	≤ 0.1% FSO	≤ 0.1% FSO
Resolution ¹⁾	static, 2Hz	approx. 0.375nm	approx. 0.95nm	approx. 1.5nm	approx. 2.25nm
	dynamic, 8.5kHz	approx. 10nm	approx. 25nm	approx. 40nm	approx. 60nm
Temperature stability ²⁾	Zero ³⁾	-10nm/K	-65nm/K	-65nm/K	-75nm/K
	Sensitivity	-5nm/K	-50nm/K	-80nm/K	-85nm/K
Temperature range	Operation	-50 ... +200°C	-50 ... +200°C	-50 ... +200°C	-50 ... +200°C
	Storage	-50 ... +200°C	-50 ... +200°C	-50 ... +200°C	-50 ... +200°C
Humidity ⁴⁾		0 ... 95 % r.H.	0 ... 95 % r.H.	0 ... 95 % r.H.	0 ... 95 % r.H.
Dimensions		Ø8 x 17mm	Ø12 x 22mm	Ø16 x 22mm	Ø24 x 30mm
Active measuring area		Ø 3.9 mm	Ø 6.3 mm	Ø 8.0 mm	Ø 9.8 mm
Guard ring width		0.8mm	1.6mm	2.7mm	4.6mm
Minimum target diameter		Ø6mm	Ø10mm	Ø14mm	Ø20mm
Weight		3.5g	11.5g	35g	80g
Material	Housing	NiFe (magn.)	1.4404 (non-magn.)	1.4404 (non-magn.)	1.4404 (non-magn.)
Connection		type C	type B	type B	type B
Mounting		Thread M8x0.5	Thread M12x1	Thread M16x1	Thread M24x1.5
Distance from the target surface for the recommended mounting option		3mm	3.5mm	3.5mm	4.5mm

FSO = Full Scale Output

¹⁾ Valid with reference controller, relates to standard measuring range, ²⁾ from more than +140°C: non-linear signal drift

³⁾ with recommended mounting option; ⁴⁾ non-condensing

Connector type C

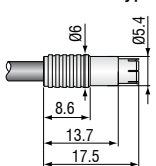

Connector type C/90

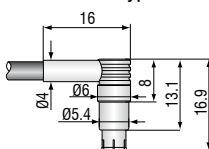

Connector type B

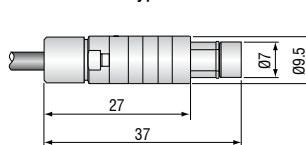

Connector type B/90

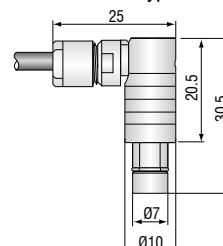

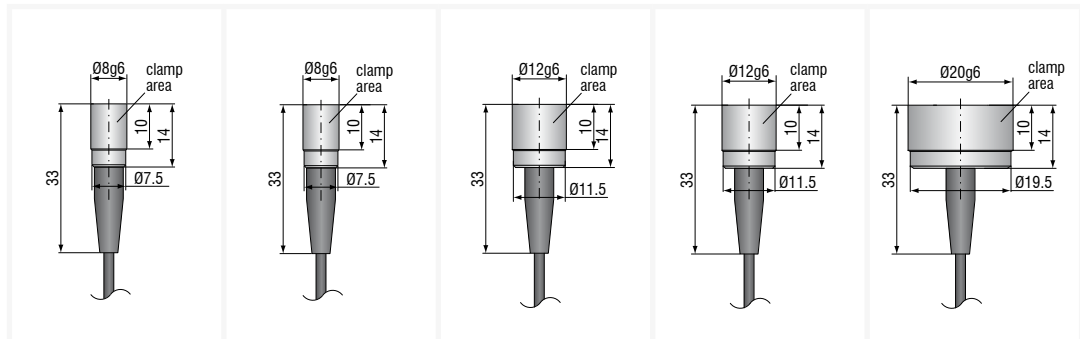

Sensor type		CSH02-CAM1,4	CSH05-CAM1,4	CSH1-CAM1,4	CSH1,2-CAM1,4	CSH2-CAM1,4
Article No.		6610086	6610087	6610088	6610089	6610107
Measuring range	reduced	0.1mm	0.25mm	0.5mm	0.6mm	1mm
	nominal	0.2mm	0.5mm	1mm	1.2mm	2mm
	extended	0.4mm	1mm	2mm	2.4mm	4mm
Linearity ¹⁾		$\leq 0.054\mu\text{m}$	$\leq 0.13\mu\text{m}$	$\leq 0.13\mu\text{m}$	$\leq 0.84\mu\text{m}$	$\leq 0.5\mu\text{m}$
		$\leq 0.027\%$ FSO	$\leq 0.026\%$ FSO	$\leq 0.013\%$ FSO	$\leq 0.07\%$ FSO	$\leq 0.025\%$ FSO
Resolution ¹⁾	static 2Hz	0.15nm	0.38nm	0.75nm	0.9nm	1.5nm
	dynamic 8.5kHz	4nm	10nm	20nm	24nm	40nm
Temperature stability	Zero ⁴⁾	-19nm/K	-19nm/K	-19nm/K	-19nm/K	-19nm/K
	Sensitivity	-2.4nm/K	-6nm/K	-12nm/K	-14.4nm/K	-24nm/K
Temperature range	Operation	-50 ... +200°C	-50 ... +200°C	-50 ... +200°C	-50 ... +200°C	-50 ... +200°C
	Storage	-50 ... +200°C	-50 ... +200°C	-50 ... +200°C	-50 ... +200°C	-50 ... +200°C
Humidity ²⁾		0% ... 95% r.H.	0% ... 95% r.H.	0% ... 95% r.H.	0% ... 95% r.H.	0% ... 95% r.H.
Dimensions ³⁾		Ø8 × 14mm	Ø8 × 14mm	Ø12 × 14mm	Ø12 × 14mm	Ø20 × 14mm
Active measuring area		Ø2.6mm	Ø4.1mm	Ø5.7mm	Ø6.3mm	Ø8.1mm
Guard ring width		1.9mm	1.2mm	2.4mm	2.1mm	4.4mm
Minimum target diameter		Ø7mm	Ø7mm	Ø11mm	Ø11mm	Ø17mm
Weight (incl. cable and connector)		30g	30g	33g	33g	38g
Material	Housing	1.4104 (magn.)	1.4104 (magn.)	1.4104 (magn.)	1.4104 (magn.)	1.4104 (magn.)
Connection	Cable integrated	Ø2.1mm × 1.4m axial	Ø2.1mm × 1.4m axial	Ø2.1mm × 1.4m axial	Ø2.1mm × 1.4m axial	Ø2.1mm × 1.4m axial
Mounting		clamping	clamping	clamping	clamping	clamping

FSO = Full Scale Output CSH Sensors are matched to controller with standard cable length

¹⁾ Valid with reference controller, relates to standard measuring range

²⁾ Non condensing; ³⁾ Without cable, bend protection and crimp

⁴⁾ In the case of a sensor mounting 2mm behind front surface

Mounting cylindrical sensors

All sensors can be installed as both freestanding and flush units.

The sensors can be clamped or fastened using a collet.

Mounting with grub screw (plastic)

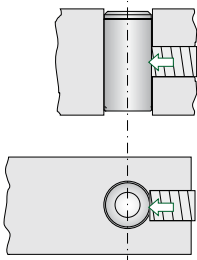

Mounting with collet

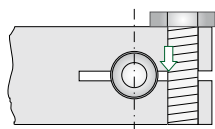

Important!

All Micro-Epsilon sensors are short circuit proof. Unlike other systems the pre-amplifier will not get damaged, if the front face of the sensor gets shorted by touching the conductive target.

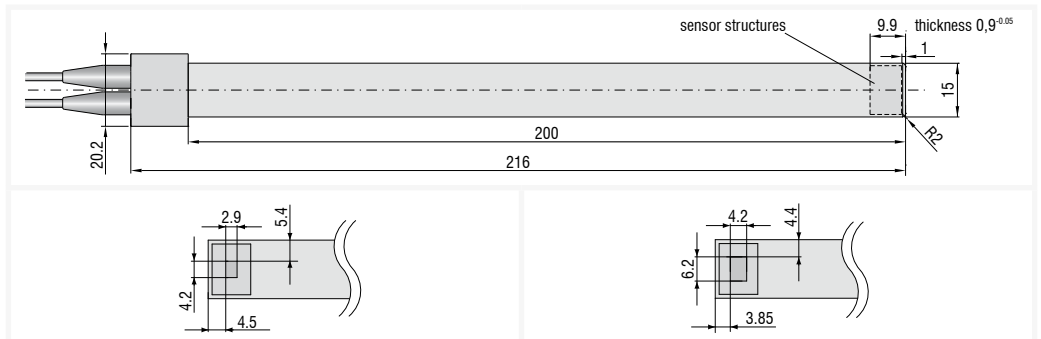

Sensor type		CSG0,50-CAm2,0	CSG1,00-CAm2,0
Article No.		6610112	6610111
Measuring range	Standard	0.5mm	1mm
Gap width ¹⁾		0.9 ... 1.9mm	0.9 ... 2.9mm
Linearity ²⁾		≤ 0.5µm	≤ 1µm
Resolution ²⁾	static 2Hz	4nm	8nm
Resolution ²⁾	dynamic 8.5kHz	90nm	180nm
Temperature stability	Zero ⁴⁾	-50nm/K	-50nm/K
	Sensitivity	-20nm/K	-40nm/K
Temperature range	Operation	-50 ... +100°C	-50 ... +100°C
	Storage	-50 ... +100°C	-50 ... +100°C
Humidity ³⁾		0 ... 95%	0 ... 95%
Dimensions (without housing)		200 x 15 x 0.9mm	200 x 15 x 0.9mm
Active measuring area		3 x 4.3mm	4.2 x 5.1mm
Guard ring width		2.7mm	2.2mm
Minimum target diameter		approx. 7 x 8mm	approx. 8 x 9mm
Weight		77g	77g
Material	Housing	1.4301	1.4301
	Sensor	FR4	FR4
Connection	Cable integrated	2 m	2 m

¹⁾ Sensor width + measuring range on both sides

²⁾ Valid with controller DT6530

³⁾ Non condensing

Connector type B

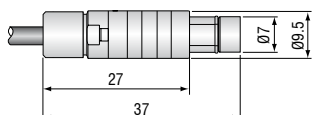

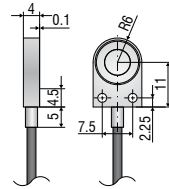
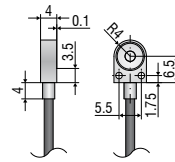
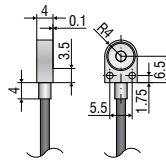

Sensor type		CSH02FL-CRm1,4	CSH05FL-CRm1,4	CSH1FL-CRm1,4
Article No.		6610075	6610085	6610072
Measuring range	reduced	0.1mm	0.25mm	0.5mm
	nominal	0.2mm	0.5mm	1mm
	extended	0.4mm	1mm	2mm
Linearity ¹⁾		≤ 0.05μm	≤ 0.09μm	≤ 0.2μm
		≤ 0.025% FSO	≤ 0.018% FSO	≤ 0.02% FSO
Resolution ²⁾	static 2Hz	0.15nm	0.38nm	0.75nm
	dynamic 8.5kHz	4nm	10nm	20nm
Temperature stability	Zero ⁴⁾	-37.6 or 2.4nm/°C	-37.6 or 2.4nm/°C	-37.6 or 2.4nm/°C
	Sensitivity	-2.4nm/K	-6nm/K	-12nm/K
Temperature range	Operation	-50... +200°C	-50... +200°C	-50... +200°C
	Storage	-50... +200°C	-50... +200°C	-50... +200°C
Humidity ²⁾		0% ... 95% r.H.	0 ... 95% r.H.	0 ... 95% r.H.
Dimensions ³⁾		10.5 × 8 × 4mm	10.5 × 8 × 4mm	17 × 12 × 4mm
Active measuring area		Ø2.6mm	Ø4.1mm	Ø5.7mm
Guard ring width		1.9mm	1.2mm	2.4mm
Minimum target diameter		Ø7mm	Ø7mm	Ø11mm
Weight (incl. cable and connector)		28g	28g	30g
Material	Housing	1.4104 (magn.)	1.4104 (magn.)	1.4104 (magn.)
Connection	Cable integrated	Ø2.1mm × 1.4m radial	Ø2.1mm × 1.4m radial	Ø2.1mm × 1.4m radial
Mounting		2x thread M2	2x thread M2	2x screw M2 DIN 84A

FSO = Full Scale Output CSH Sensors are matched to controller with standard cable length

¹⁾ Valid with reference controller, relates to standard measuring range

²⁾ Non condensing

³⁾ Without cable, bend protection and crimp

⁴⁾ In the case of a sensor mounting on the top or underside

Mounting flat sensors

The flat sensors are attached using a threaded bore for M2 (for the sensors CSH02FL and CSH05FL) or using a through-hole for M2 bolts. The sensors can be bolted on top or below.

Screw connection from above on the underside

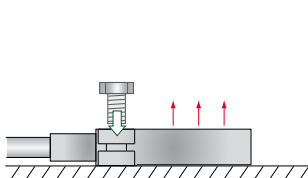

Screw connection from below on the sensor top side

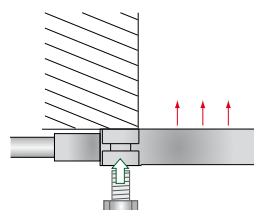

Connector for integrated cables

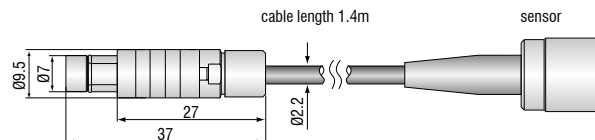

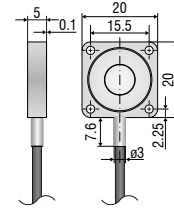
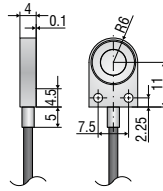

Sensor type		CSH1,2FL-CRm1,4	CSH2FL-CRm1,4
Article No.		6610077	6610094
Measuring range	reduced	0.6mm	1mm
	nominal	1.2mm	2mm
	extended	2.4mm	4mm
Linearity ¹⁾		0.84μm 0.07% FSO	0.32μm 0.016% FSO
Resolution ²⁾	static 2Hz	0.9nm	1.5nm
	dynamic 8.5kHz	24nm	40nm
Temperature stability	Zero ⁴⁾	-37.6 or 2.4nm/°C	-47 or 4nm/K
	Sensitivity	-14.4nm/K	-24nm/K
Temperature range	Operation	-50...+200°C	-50...+200°C
	Storage	-50...+200°C	-50...+200°C
Humidity ²⁾		0 ... 95% r.H.	0 ... 95% r.H.
Dimensions ³⁾		17 × 12 × 4mm	20 × 20 × 5mm
Active measuring area		Ø6.3mm	Ø8.1mm
Guard ring width		2.1mm	4.4mm
Minimum target diameter		Ø11mm	Ø17mm
Weight (incl. cable and connector)		30g	36g
Material	Housing	1.4104 (magn.)	1.4104 (magn.)
Connection	Cable integrated	Ø2.1mm×1.4m radial	Ø2.1mm×1.4m radial
Mounting		2x screw M2 DIN 84A	4x screw M2 DIN 84A

FSO = Full Scale Output CSH Sensors are matched to controller with standard cable length

¹⁾ Valid with reference controller, relates to standard measuring range

²⁾ Non condensing

³⁾ Without cable, bend protection and crimp

⁴⁾ In the case of a sensor mounting on the top or underside

High performance sensors made by Micro-Epsilon



Sensors and systems for displacement and position



Sensors and measurement devices for non-contact temperature measurement



2D/3D profile sensors (laser scanner)



Optical micrometers, fibre optic sensors and fibre optics



Color recognition sensors, LED analyzers and color inline spectrometer



Measurement and inspection systems